

# VEHICLE SERVICES CATALOG

*Complete Storage & Workspace Solutions*

## **ABOUT STANLEY BLACK & DECKER STORAGE SOLUTIONS**

Stanley Black & Decker Storage Solutions is a global provider of high-density storage solutions that help workforces work efficiently and safely. We partner with businesses to design customized storage and workspace systems that maximize productivity while saving space. Our trusted brands Lista<sup>®</sup>, Vidmar<sup>®</sup>, and InnerSpace<sup>®</sup> make up the broadest storage portfolio in the marketplace and enable us to provide tailored, cost-effective solutions to our customers' unique storage challenges. For more information, visit <http://storage.stanleyblackanddecker.com/>





# VEHICLE SERVICE CAPABILITIES CATALOG

<b>OVERVIEW</b>	<b>2-5</b>
Space Evaluation .....	4-5

<b>VALET STATIONS</b>	<b>6-7</b>
-----------------------	------------

<b>SERVICE BAYS</b>	<b>8-25</b>
How to Order .....	10-11
750 Series .....	12-19
900 Series .....	20-23
Garage Cabinets .....	24-25

<b>TECHNICIAN SERIES TOOLBOXES</b>	<b>26-37</b>
750 Series .....	28-29
900 Series .....	30-31
1050 Series .....	32-33
Base Options .....	34
Paint Colors .....	35
Drawer Pulls .....	35
Tops .....	36
Drawer Interiors .....	37

<b>SEATING SOLUTIONS</b>	<b>38</b>
--------------------------	-----------

<b>E-SERIES STORAGE SOLUTIONS</b>	<b>39-41</b>
Workstations .....	39
Roller Cabinets .....	40
Carts .....	41

<b>PARTS COUNTERS</b>	<b>42-43</b>
Preconfigured Pods .....	43

<b>PARTS STORAGE</b>	<b>44-57</b>
Cabinets .....	44-45
Shelf Converters .....	46-57

<b>VERTICAL SOLUTIONS</b>	<b>58-59</b>
STAK System® .....	58
Vertical Lift Module .....	58
Adjustable Racking System .....	59
Tire Carousel .....	59
How to order .....	60
Paint Colors .....	61



**SLEEK.  
DURABLE.  
ORGANIZED.**

**YOUR DEALERSHIP NEVER LOOKED  
SO GOOD.**

For decades, the automotive industry has trusted Lista® and Vidmar® for the storage and workspace equipment they need to provide the efficient, quality service their customers demand.

Our sleek, high-density storage and workspace solutions:

- Keep your dealership organized, optimized, and operating efficiently
- Equip your technicians with the best tools to do the job at hand
- Project a polished, professional image that customers can have confidence in



# VEHICLE SERVICES

## YOUR ONE-STOP SHOP FOR STORAGE SOLUTIONS

**We know that time is money** in your dealership and job turnaround is critical to your profitability. That's why we've designed storage systems that maximize every cubic inch of available space and time-saving workspaces that shift your productivity into overdrive.

**We know that no two shops are alike.** That's why you can customize any solution to your specific needs. Every product is built to order, configurable, and backed by a lifetime guarantee – so you get what you want every time.

**We know image matters.** Your Service and Parts Departments are on display just like your showroom. They need to project order, cleanliness, and professionalism. That's why we offer functional solutions that are "dressed to impress".

From the Service Drive to the Service Department to the Parts Department and everywhere in between – we've got you covered.

**UNRIVALED PERFORMANCE.  
UNBELIEVABLE EFFICIENCY.  
UNCOMPROMISED QUALITY.**

Trust the storage and workspace leaders.

Trust Lista® and Vidmar®.



## SPACE EVALUATION

At Lista, we don't just sell a product. We design a customized solution around your business's unique needs and operations.

You get a customized plan to maximize space and efficiency in your facility. Any project, any size – free of charge. We perform a floor space utilization analysis and create floorplan designs for your facility. And we create a customized CAD and/or photorealistic renderings of solutions that optimize your space and maximize efficiency in your facility. Any project, any size – free of charge.

There's no obligation. You decide what makes sense for you.

Helping workforces work better is what we do.  
ListaWorks™ is how we do it.

Contact us to request your ListaWorks™ design evaluation today.

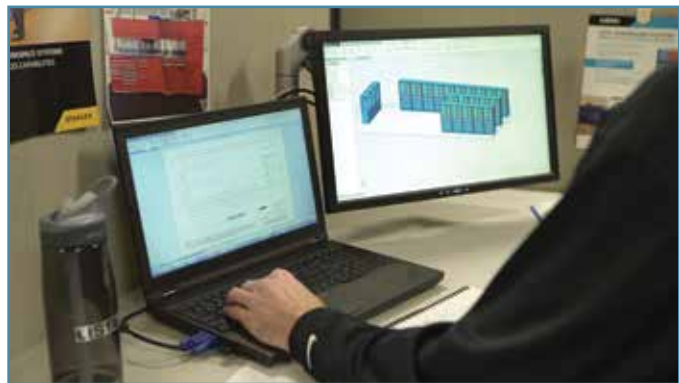



## FACILITY-WIDE SOLUTIONS

Service Bays & Toolboxes



Essential Tool Cabinets



Parts Department

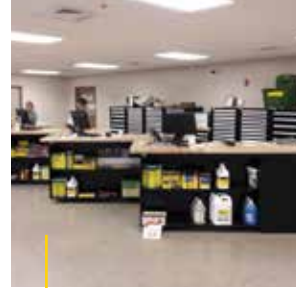

Valet Station



Mobile Tool Storage

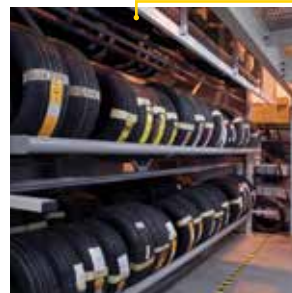

Vertical Product and Carousels



# VALET STATIONS THAT SET THE TONE

Your Service Drive. It's the first touchpoint within your Service Department – where your Service Writers greet customers and check them in for vehicle work. You need to project an image that impresses and inspires confidence.

The Lista® Valet Station doesn't disappoint. Designed specifically for your service check-in area, it gives your service attendants everything they need to process customers with ease and speed.



Rear panel features power strips equipped with USB ports and wire management capability

Clean, professional-looking stainless steel work surface

Available in 6 footprints and a variety of custom product enhancements to increase productivity

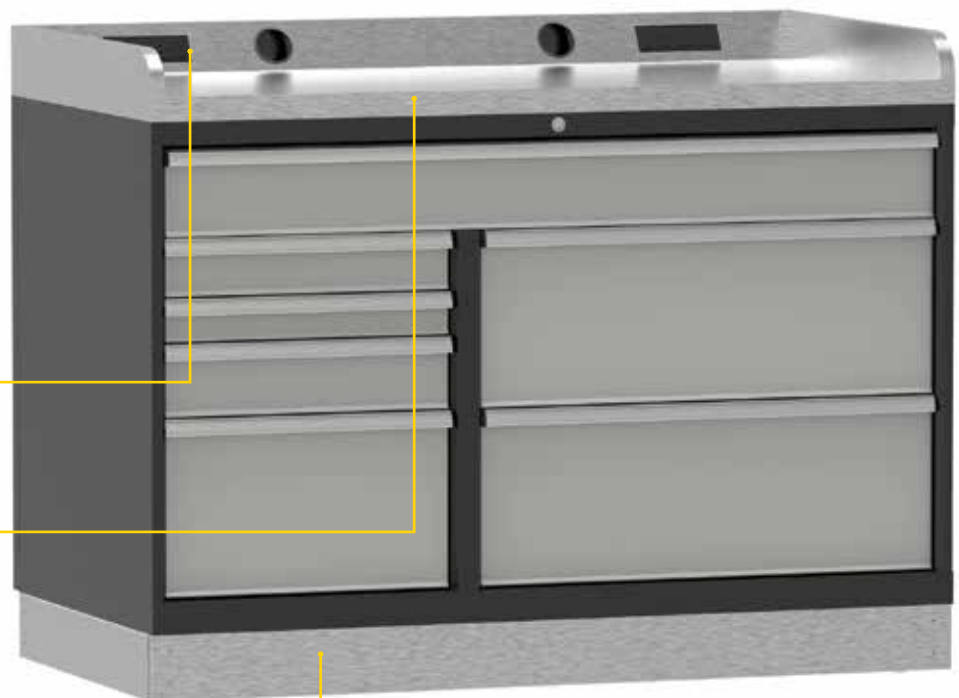

Valet Station



# VEHICLE SERVICES



TSPS0750-03428

42.15"H X 30"D X 34"W



TSVS0750-05628-01

42.15"H X 30"D X 56.5"W



TSVS0750-05622-01

42.15"H X 24"D X 56.5"W



TSVS0750-09122-01

42.15"H X 24"D X 91"W



TSVS0750-09128-01

42.15"H X 30"D X 91"W



TSVS0750-12522-01

42.15"H X 24"D X 125.14"W



TSVS0750-12528-01

42.15"H X 30"D X 125.14"W

Valet Stations

# SERVICE BAYS THAT TURBOCHARGE YOUR EFFICIENCY

Your Service Department is a major profitability center for your dealership. It's also one of the busiest, most visible areas of your facility. So it needs to be outfitted for optimum technician efficiency while presenting a clean, uniform look to your customers.

That's where Vidmar® and Lista® come in. We specialize in designing custom solutions that conform exactly to your shop's infrastructure. Engineered with flexibility, durability, and efficiency in mind, our service bays and technician toolboxes create a clean, coordinated, organized workspace that enhances your image, promotes productivity, and helps retain skilled technicians.

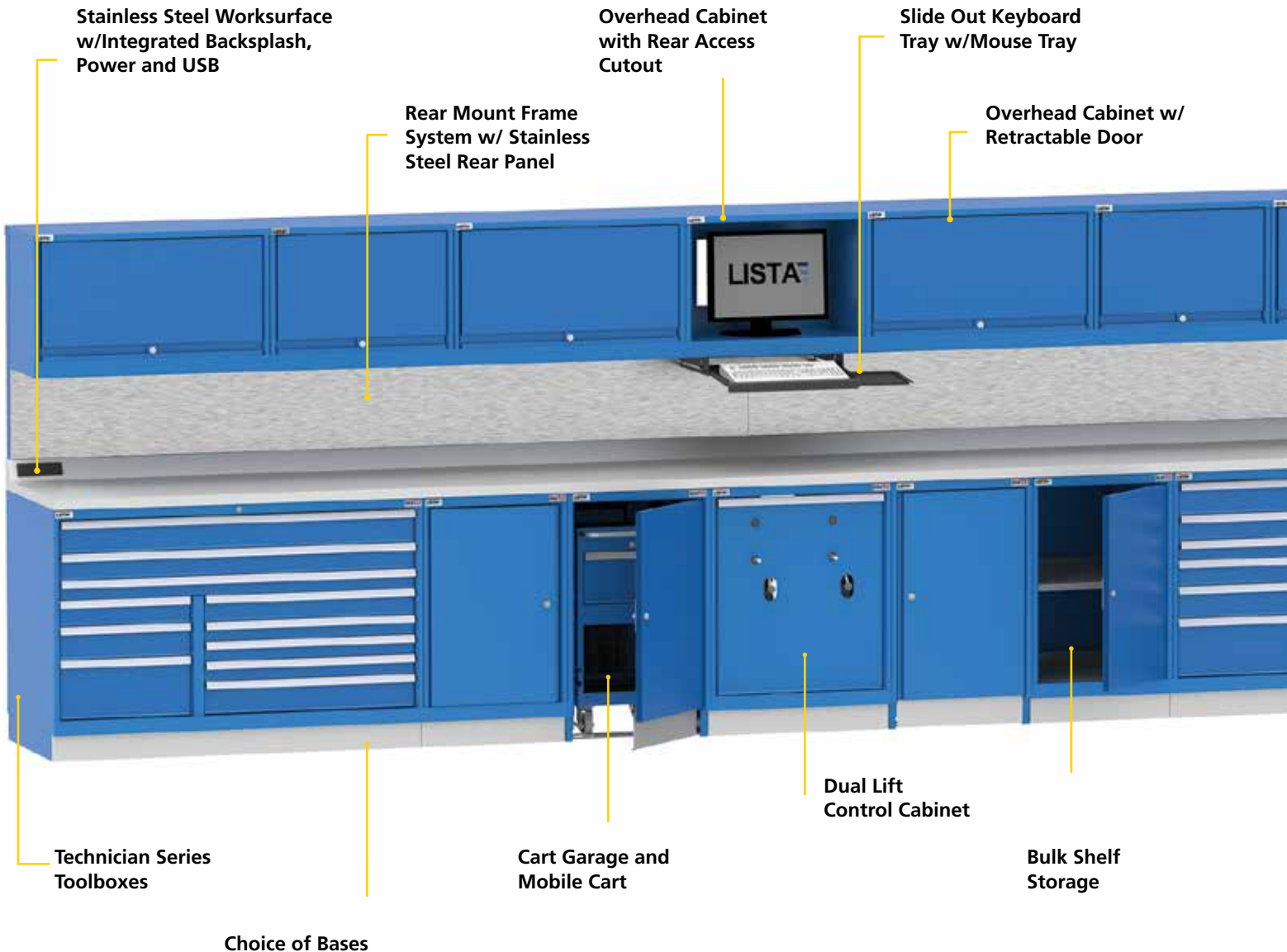

# VEHICLE SERVICES



Service Department

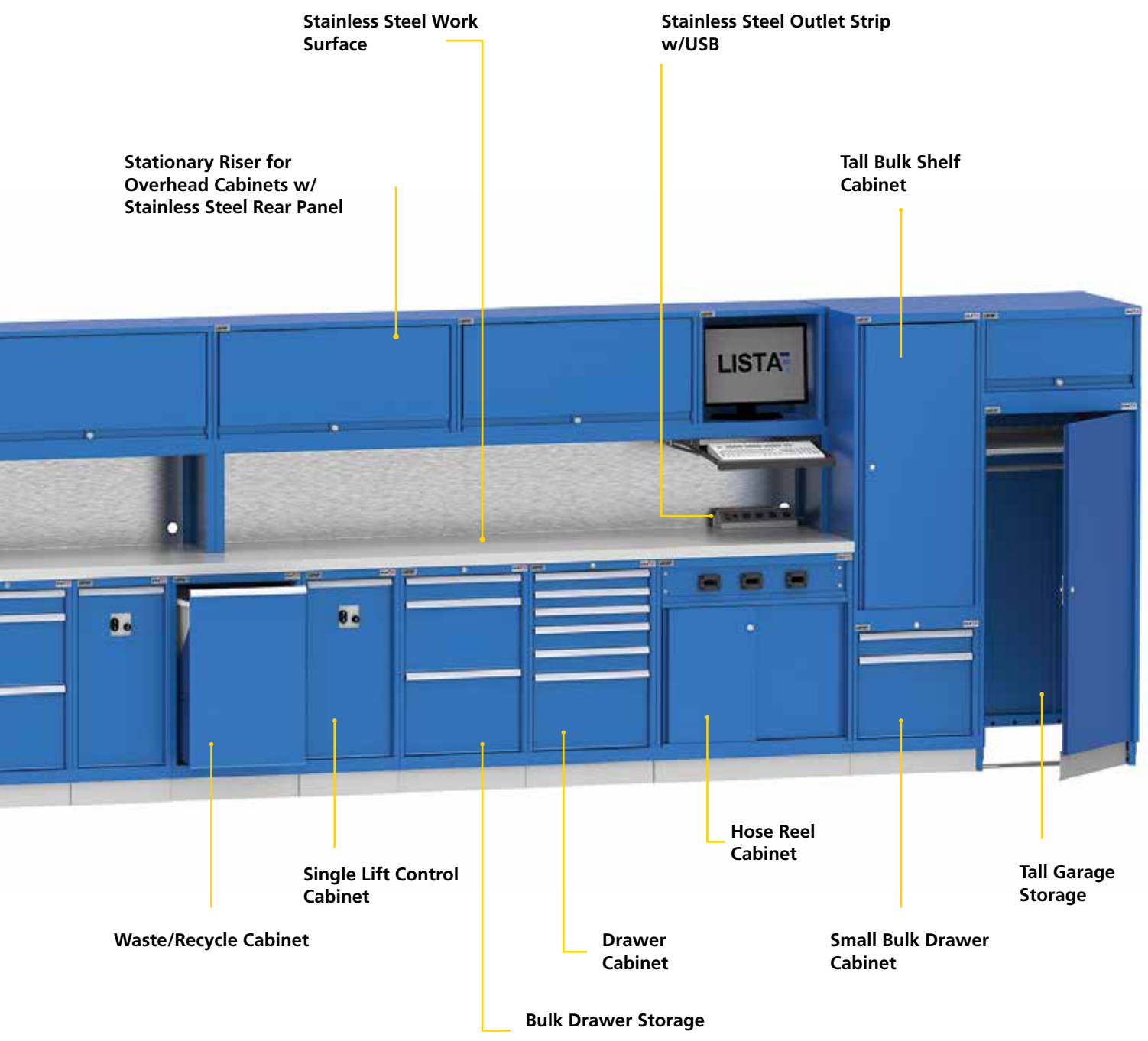



# SELECTING YOUR SERVICE BAYS

## How to choose Service Bays

1. Select your bench height  
(pages 10-11)
  2. Determine available length for single and/or double bays (bench length)  
(pages 12-15)
  3. Define needs for each bay (pump control, storage, cart garage, etc.)  
(750 series page 16  
900 series page 21)
  4. Review pre-configured options and select appropriate configuration  
(750 series pages 12-15  
900 series page 20)
- Can't find exactly what you want?  
Modify components or build from scratch**

## 1. SELECT BENCH HEIGHT

### CHOOSING YOUR BENCH HEIGHT

*Dimensions below are in inches and include a 1.75" thick worksurface*

BASE TYPE	2" LEVELING BASE		4" LEVELING BASE		WET CLEAN BASE	
	Min.	Max.	Min.	Max.	Min.	Max.
Cabinet Model						
750	37.19	38.17	39.15	40.14	40.32	41.82
900	43.09	44.07	45.06	46.04	46.22	47.72

Some factors to consider when selecting a bench height:

- Recommended bench height is at or slightly below elbow height
- For heavier work a slightly shorter bench is recommended
- For more precise work a slightly taller bench is recommended
- Average US male is 69.7" (2016 data)
- Male Elbow height is 0.630 as percentage of height
- Average US male elbow height is  $69.7 \times 0.630 = 43.9"$
- Average US female is 63.8" (2016 data)
- Female elbow height is 0.632 as percentage of height
- Average US female elbow height is  $63.8 \times 0.632 = 40.32"$





## SERVICE BAY HEIGHT OFFERINGS

### 750 Double Bay

76.77"H x 31.17"D x 108.9"W

Total Sq. In. 6,598

Total Cu. In. 73,393

Totals include Base and Overhead cabinets



### 900 Double Bay

74.8"H x 31.17"D x 108.9"W

Total Sq. In. 8,775

Total Cu. In. 84,535

Totals include Base and Overhead cabinets



Service Department

900 VS 750	SQ. IN.	CU. IN.
Additional Sq. & Cu. In. vs 750 by %	33%	15%
Additional Cost vs 750 by %	13%	

*This data is based on the configurations shown on this page and will vary based on selected configurations.*

## 2. SINGLE SERVICE BAYS - 750 SERIES

### How to order Preconfigured Service Bays

1. Select Service Bay configuration on pages 12-15, 20.
2.  Select lock type
3.  Select paint color.  
For color chart, see page 61

**EXAMPLE:** to order a MP0750-0318FV-4LB cabinet with individual lock and red paint, the part ordering number would be MP0750-0318FV-4LB-RG-NR



**TSB750SF02LB4** 66.7"W X 31.17"D X 76.77 H"

**COMPONENTS**

- MP0750-0318FV-4LB  Bulk 3 Drawer Cabinet
- CL0750-\_\_\_\_-4LB  Cabinet, Lift Control \_\_\_\_ Pump
- MP0750-WRC-4LB  Cabinet, Waste/Recycle
- SST29.0X066.7/ELU0 Stainless Steel worktop w/integrated power
- 3 EA. - OHCF-72.8 Rear Mount Frame Upright
- 3 EA. - OHCF-CH23 OHC Channel
- 1 EA. - OHCF-P66.6X14-S Stainless Steel Rear Panel
- 1 EA. - OHCF-F66.6 Front Valance
- 1 EA. - OHCF-VS15 Side Valance Kit
- 1 EA. - OHCF-KBT Keyboard/Mouse Tray
- 2 EA. - OHC2320-RD  Cabinet, Overhead w/ Retractable Door
- 1 EA. - OHC2320/JA025  Cabinet, Overhead no Door w/RCO



**TSB750SF06LB4** 66.7"W X 31.17"D X 76.77 H"

**COMPONENTS**

- MP0750-0318FV-4LB  Bulk 3 Drawer Cabinet
- MP750CG-X-4LB  Garage, Mobile Cart
- CL0750-\_\_\_\_-4LB  Cabinet, Lift Control \_\_\_\_ Pump
- SST29.0X066.7/ELU0 Stainless Steel worktop w/integrated power
- 3 EA. - OHCF-72.8 Rear Mount Frame Upright
- 3 EA. - OHCF-CH23 OHC Channel
- 1 EA. - OHCF-P66.6X14-S Stainless Steel Rear Panel
- 1 EA. - OHCF-F66.6 Front Valance
- 1 EA. - OHCF-VS15 Side Valance Kit
- 1 EA. - OHCF-KBT Keyboard/Mouse Tray
- 2 EA. - OHC2320-RD  Cabinet, Overhead w/ Retractable Door
- 1 EA. - OHC2320/JA025  Cabinet, Overhead no Door w/RCO



**TSB750SF11LB4** 57.2"W X 31.17"D X 76.77 H"

**COMPONENTS**

- HWHD750-4LB  Bulk 3 Shelf Cabinet
- NS0750-\_\_\_\_-4LB  Cabinet, Lift Control \_\_\_\_ Pump
- SST29.0X057.2/ELU0 Stainless Steel worktop w/integrated power
- 2 EA. - OHCF-72.8 Rear Mount Frame Upright
- 1 EA. - OHCF-CH23 OHC Channel
- 1 EA. - OHCF-CH34.25 OHC Channel
- 1 EA. - OHCF-P90.7X14-S Stainless Steel Rear Panel
- 1 EA. - OHCF-F90.7 Front Valance
- 1 EA. - OHCF-VS15 Side Valance Kit
- 1 EA. - OHCF-KBT Keyboard/Mouse Tray
- 1 EA. - OHC34.2520-RD  Cabinet, Overhead w/ Retractable Door
- 1 EA. - OHC2320/JA025  Cabinet, Overhead no Door w/RCO



# VEHICLE SERVICES



750 Series



**TSB750SF13LB4** 56.5"W X 31.17"D X 76.77 H"

**COMPONENTS**

- EW0750-0318FV-4LB Bulk 3 Drawer Cabinet
- MP750CG-X-4LB Garage, Mobile Cart
- SST29.0X056.5/ELU0 Stainless Steel worktop w/integrated power
- 2 EA. - OHCF-72.8 Rear Mount Frame Upright
- 1 EA. - OHCF-CH23 OHC Channel
- 1 EA. - OHCF-CH34.25 OHC Channel
- 1 EA. - OHCF-P90.7X14-S Stainless Steel Rear Panel
- 1 EA. - OHCF-F90.7 Front Valance
- 1 EA. - OHCF-V/S15 Side Valance Kit
- 1 EA. - OHCF-KBT Keyboard/Mouse Tray
- 1 EA. - OHC34.2520-RD Cabinet, Overhead w/ Retractable Door
- 1 EA. - OHC2320/JA025 Cabinet, Overhead no Door w/RCO



**TSB750SF15LB4** 44.5"W X 31.17"D X 76.77 H"

**COMPONENTS**

- MP0750-0318FV-4LB Bulk 3 Drawer Cabinet
- MP750CG-X-4LB Garage, Mobile Cart
- SST-29.0X044.5/ELU0 Stainless Steel worktop w/integrated power
- 2 EA. - OHCF-72.8 Rear Mount Frame Upright
- 2 EA. - OHCF-CH23 OHC Channel
- 1 EA. - OHCF-P44.4X14-S Stainless Steel Rear Panel
- 1 EA. - OHCF-F44.4 Front Valance
- 1 EA. - OHCF-V/S15 Side Valance Kit
- 1 EA. - OHCF-KBT Keyboard/Mouse Tray
- 1 EA. - OHC2320-RD Cabinet, Overhead w/ Retractable Door
- 1 EA. - OHC2320/JA025 Cabinet, Overhead no Door w/RCO



**TSB750SF17LB4** 117.8"W X 31.17"D X 76.77 H"

**COMPONENTS**

- TSDW07C04-1101FL-4LB Double Bank 11 Drawer Toolbox
- MP0750-0622FV-4LB 6 Drawer Cabinet
- MP750CG-X-4LB Garage, Mobile Cart
- NS0750-\_\_\_-4LB Cabinet, Lift Control \_\_\_ Pump
- SST29.0X117.8/ELU0 Stainless Steel worktop w/integrated power
- 3 EA. - OHCF-72.8 Rear Mount Frame Upright
- 1 EA. - OHCF-CH23 OHC Channel
- 1 EA. - OHCF-CH47 OHC Channel
- 1 EA. - OHCF-CH48 OHC Channel
- 1 EA. - OHCF-P117.2X14-S Stainless Steel Rear Panel
- 1 EA. - OHCF-F117.2 Front Valance
- 1 EA. - OHCF-V/S15 Side Valance Kit
- 1 EA. - OHCF-KBT Keyboard/Mouse Tray
- 1 EA. - OHC2320/JA025 Cabinet, Overhead no Door w/RCO
- 1 EA. - OHC4720-RD Cabinet, Overhead w/ Retractable Door
- 1 EA. - OHC4820-RD Cabinet, Overhead w/ Retractable Door



**TSB750SF19LB4** 117.8"W X 31.17"D X 76.77 H"

**COMPONENTS**

- MP0750-WRC-4LB Cabinet, Waste/Recycle
- NS0750-\_\_\_-4LB Cabinet, Lift Control \_\_\_ Pump
- MP750CG-X-4LB Garage, Mobile Cart
- TSDW07C04-1003FL-4LB Double Bank 10 Drawer Cabinet
- MP0450-0206FV-4LB Bulk 2 Drawer Cabinet
- MP1200-0310-4LB Bulk 3 Shelf Cabinet (Left Hinged Door)
- SST29.0X117.8/ELU0 Stainless Steel worktop w/integrated power
- 3 EA. - OHCF-72.8 Rear Mount Frame Upright
- 1 EA. - OHCF-CH23 OHC Channel
- 1 EA. - OHCF-CH47 OHC Channel
- 1 EA. - OHCF-CH48 OHC Channel
- 1 EA. - OHCF-P117.2X14-S Stainless Steel Rear Panel
- 1 EA. - OHCF-F117.2 Front Valance
- 1 EA. - OHCF-V/S15 Side Valance Kit
- 1 EA. - OHCF-KBT Keyboard/Mouse Tray
- 1 EA. - OHC2320/JA025 Cabinet, Overhead no Door w/RCO
- 1 EA. - OHC4720-RD Cabinet, Overhead w/ Retractable Door
- 1 EA. - OHC4820-RD Cabinet, Overhead w/ Retractable Door

## 2. DOUBLE SERVICE BAYS - 750 SERIES

### How to order Preconfigured Service Bays

1. Select Service Bay configuration on pages 12-15, 20.
2.  Select lock type
3.  Select paint color.  
For color chart, see page 61

**EXAMPLE:** to order a **MP0750-0318FV-4LB** cabinet with individual lock and red paint, the part ordering number would be **MP0750-0318FV-4LB-RG-NR**



**TSB750DF02LB4** 100.6"W X 31.17"D X 76.77 H"

#### COMPONENTS

- MP0750-0318FV-4LB  Bulk 3 Drawer Cabinet
- NS0750-\_\_\_\_-4LB  Cabinet, Lift Control \_\_\_\_ Pump
- MP0750-WRC-4LB  Cabinet, Waste/Recycle
- NS0750-\_\_\_\_-4LB  Cabinet, Lift Control \_\_\_\_ Pump
- MP0750-0318FV-4LB  Bulk 3 Drawer Cabinet
- SST29.0X100.6/EBU0 Stainless Steel worktop w/integrated power
- 3 EA. - OHCF-72.8 Rear Mount Frame Upright
- 1 EA. - OHCF-CH28 OHC Channel
- 2 EA. - OHCF-CH36 OHC Channel
- 1 EA. - OHCF-P100.2X14-S Stainless Steel Rear Panel
- 1 EA. - OHCF-F100.2 Front Valance
- 1 EA. - OHCF-V/S15 Side Valance Kit
- 1 EA. - OHCF-KBT Keyboard/Mouse Tray
- 2 EA. - OHC3620-RD  Cabinet, Overhead w/ Retractable Door
- 1 EA. - OHC2820/JA025  Cabinet, Overhead no Door w/RCO



**TSB750DF06LB4** 117.3"W X 31.17"D X 76.77 H"

#### COMPONENTS

- MP0750-0318FV-4LB  Bulk 3 Drawer Cabinet
- MP750CG-X-4LB  Garage, Mobile Cart
- ST0750-\_\_\_\_-4LB  Cabinet, Lift Control \_\_\_\_ Pump
- MP750CG-X-4LB  Garage, Mobile Cart
- MP0750-0318FV-4LB  Bulk 3 Drawer Cabinet
- SST29.0X117.3/EBU0 Stainless Steel worktop w/integrated power
- 4 EA. - OHCF-72.8 Rear Mount Frame Upright
- 1 EA. - OHCF-CH23 OHC Channel
- 2 EA. - OHCF-CH47 OHC Channel
- 1 EA. - OHCF-P116.1X14-S Stainless Steel Rear Panel
- 1 EA. - OHCF-F116.1 Front Valance
- 1 EA. - OHCF-V/S15 Side Valance Kit
- 1 EA. - OHCF-KBT Keyboard/Mouse Tray
- 2 EA. - OHC4720-RD  Cabinet, Overhead w/ Retractable Door
- 1 EA. - OHC2320/JA025  Cabinet, Overhead no Door w/RCO



**TSB750DF11LB4** 108.9"W X 31.17"D X 76.77 H"

#### COMPONENTS

- HWHD750-4LB  Bulk 3 Shelf Cabinet
- ST0750-\_\_\_\_-4LB  Cabinet, Lift Control \_\_\_\_ Pump
- HWHD750-4LB  Bulk 3 Shelf Cabinet
- SST29.0X108.9/EBU0 Stainless Steel worktop w/integrated power
- 4 EA. - OHCF-72.8 Rear Mount Frame Upright
- 1 EA. - OHCF-CH28 OHC Channel
- 2 EA. - OHCF-CH40 OHC Channel
- 1 EA. - OHCF-P108.8X14-S Stainless Steel Rear Panel
- 1 EA. - OHCF-F108.8 Front Valance
- 1 EA. - OHCF-V/S15 Side Valance Kit
- 1 EA. - OHCF-KBT Keyboard/Mouse Tray
- 2 EA. - OHC4020-RD  Cabinet, Overhead w/ Retractable Door
- 1 EA. - OHC2820/JA025  Cabinet, Overhead no Door w/RCO

# VEHICLE SERVICES



750 Series



**TSB750DF13LB4** 113.1"W X 31.17"D X 76.77"H

**COMPONENTS**

- EW0750-0318FV-4LB  Bulk 3 Drawer Cabinet
- MP750CG-X-4LB  Garage, Mobile Cart
- MP750CG-X-4LB  Garage, Mobile Cart
- EW0750-0318FV-4LB  Bulk 3 Drawer Cabinet
- SST29.0X113.1/EBU0 Stainless Steel worktop w/integrated power
- 3 EA. - OHCF-72.8 Rear Mount Frame Upright
- 1 EA. - OHCF-CH28 OHC Channel
- 2 EA. - OHCF-CH42 OHC Channel
- 1 EA. - OHCF-P112.2X14-S Stainless Steel Rear Panel
- 1 EA. - OHCF-F112.2 Front Valance
- 1 EA. - OHCF-V/S15 Side Valance Kit
- 1 EA. - OHCF-KBT Keyboard/Mouse Tray
- 2 EA. - OHC4220-RD  Cabinet, Overhead w/ Retractable Door
- 1 EA. - OHC2820/JA025  Cabinet, Overhead no Door w/RCO



**TSB750DF15LB4** 89"W X 31.17"D X 76.77"H

**COMPONENTS**

- MP0750-0318FV-4LB  Bulk 3 Drawer Cabinet
- MP750CG-X-4LB  Garage, Mobile Cart
- MP750CG-X-4LB  Garage, Mobile Cart
- MP0750-0318FV-4LB  Bulk 3 Drawer Cabinet
- SST29.0X089.0/EBU0 Stainless Steel worktop w/integrated power
- 3 EA. - OHCF-72.8 Rear Mount Frame Upright
- 1 EA. - OHCF-CH28 OHC Channel
- 2 EA. - OHCF-CH30 OHC Channel
- 1 EA. - OHCF-P88.2X14-S Stainless Steel Rear Panel
- 1 EA. - OHCF-F88.2 Front Valance
- 1 EA. - OHCF-V/S15 Side Valance Kit
- 1 EA. - OHCF-KBT Keyboard/Mouse Tray
- 2 EA. - OHC3020-RD  Cabinet, Overhead w/ Retractable Door
- 1 EA. - OHC2820/JA025  Cabinet, Overhead no Door w/RCO



**TSB750DF17LB4** 100.9"W X 31.17"D X 76.77"H (LEFT)  
129.2"W X 31.17"D X 76.77"H (RIGHT)

**COMPONENTS**

- TSDW07C04-1101FL-4LB  Double Bank 11 Drawer Toolbox
- MP0750-0622FV-4LB  6 Drawer Cabinet
- MP750CG-X-4LB  Garage, Mobile Cart
- ST0750-\_\_\_\_-4LB  Cabinet, Lift Control \_\_\_\_ Pump
- MP750CG-X-4LB  Garage, Mobile Cart
- MP0750-0622FV-4LB  6 Drawer Cabinet
- TSDW07C04-1101FL-4LB  Double Bank 11 Drawer Toolbox
- SST29.0x100.9/ELU1 Stainless Steel worktop w/integrated power
- SST29.0X129.2/ERU1 Stainless Steel worktop w/integrated power
- 6 EA. - OHCF-72.8 Rear Mount Frame Upright
- 3 EA. - OHCF-CH28 OHC Channel
- 4 EA. - OHCF-CH36 OHC Channel
- 2 EA. - OHCF-P114.3X14-S Stainless Steel Rear Panel
- 2 EA. - OHCF-F114.3 Front Valance
- 1 EA. - OHCF-V/S15 Side Valance Kit
- 1 EA. - OHCF-KBT Keyboard/Mouse Tray
- 4 EA. - OHC3620-RD  Cabinet, Overhead w/ Retractable Door
- 2 EA. - OHC2820-RD  Cabinet, Overhead w/ Retractable Door
- 1 EA. - OHC2820/JA025  Cabinet, Overhead no Door w/RCO



**TSB750DF19LB4** 95.5"W X 31.17"D X 76.77"H  
117.8"W X 31.17"D X 76.77"H (RIGHT)

**COMPONENTS**

- MP0450-0206FV-4LB  Bulk 2 Drawer Cabinet
- MP1200-0309-4LB  Bulk 3 Shelf Cabinet (Right Hinged Door)
- TSDW07C04-1003FL-4LB  Double Bank 10 Drawer Cabinet
- MP750CG-X-4LB  Garage, Mobile Cart
- NS0750-\_\_\_\_-4LB  Cabinet, Lift Control \_\_\_\_ Pump
- MP0750-WRC-4LB  Cabinet, Waste/Recycle
- NS0750-\_\_\_\_-4LB  Cabinet, Lift Control \_\_\_\_ Pump
- MP750CG-X-4LB  Garage, Mobile Cart
- TSDW07C04-1003FL-4LB  Double Bank 10 Drawer Cabinet
- MP0450-0206FV-4LB  Bulk 2 Drawer Cabinet
- MP1200-0310-4LB  Bulk 3 Shelf Cabinet (Left Hinged Door)
- SST29.0X095.5/ELU1 Stainless Steel worktop w/integrated power
- SST29.0X117.8/ERU1 Stainless Steel worktop w/integrated power
- 6 EA. - OHCF-72.8 Rear Mount Frame Upright
- 2 EA. - OHCF-CH23
- 4 EA. - OHCF-CH42
- 2 EA. - OHCF-P106.2X14-S Stainless Steel Rear Panel
- 2 EA. - OHCF-F106.2 Front Valance
- 1 EA. - OHCF-V/S15
- 2 EA. - OHCF-KBT
- 4 EA. - OHC4220-RD  Cabinet, Overhead w/ Retractable Door
- 2 EA. - OHC2320/JA025  Cabinet, Overhead no Door w/RCO



### 3. LIFT CONTROL CABINETS 750 (33.46" H)

#### ROTARY LIFT CONTROL CABINETS

■ Select: Base ■ Select: Lock □ Select: Paint Color

**EXAMPLE:** to order a black ST0750-SL210I cabinet with 2" leveling base and no lock, the part ordering number would be ST0750-SL210I-2LB-NL-BK.

SL210I		SL210		SHOCKWAVE
SINGLE	DOUBLE	SINGLE	DOUBLE	SINGLE
				
NS0750-SL210I-■-■-□ 16.85"W x 22.52"D	ST0750-SL210I-■-■-□ 28.23"W x 22.52"D	NS0750-SL210-■-■-□ 16.85"W x 22.52"D	ST0750-SL210-■-■-□ 28.23"W x 22.52"D	MP0750-SWP-■-■-□ 22.2"W x 28.54"D
CL0750-SL210I-■-■-□ 22.2"W x 22.52"D		CL0750-SL210-■-■-□ 22.2"W x 22.52"D		

### CHALLENGER LIFT CONTROL CABINETS

■ Select: Base ■ Select: Lock □ Select: Paint Color

CS1020WVBMC	
SINGLE	DOUBLE
	
NS0750-CBMC-■-■-□ 16.85"W x 22.52"D	ST0750-CBMC-■-■-□ 28.23"W x 22.52"D
CL0750-CBMC-■-■-□ 22.2"W x 22.52"D	



### 3. WASTE RECEPTACLE CABINETS 750 (33.46" H)

■ Select: Base ■ Select: Lock □ Select: Paint Color

		
NW0750-WRC-■-■-□ 16.85"W x 28.54"D	MP0750-WRC-■-■-□ 22.2"W x 28.54"D	SC0750-WRC-■-■-□ 28.23"W x 28.54"D



## 3. CART GARAGES 750 (33.46" H) CART GARAGES FOR MOBILE CARTS

■ Select: Base ■ Select: Lock □ Select: Paint Color

Replace "X" with L for left hand hinged door R for right hand hinged door (shown)

**EXAMPLE:** to order a black ST0750-SL210I cabinet with 2" leveling base and no lock, the part ordering number would be ST0750-SL210I-2LB-NL-BK.



**MP750CG-X-■-■-□**  
22.2"W x 28.54"D



**SC750CG-X-■-■-□**  
28.23"W x 28.54"D

750 Series

## 3. MOBILE CARTS

■ Select: Lock □ Select: Paint Color

NS 31 1/2" carts fit in all MP 750 or larger garages.

NS 35 1/2" carts fit in MP750 with 4" base or larger garages.

ST carts do not fit in any garages.



**NS TECHNICIAN CARTS (17 1/2" W X 26" D) SHELF ONLY**

PART NO.	DESCRIPTION
<b>TECHNICIAN CART (31 1/2" H)</b>	
MSCA2/31-NS-■-□	2-shelf
MSCA3/31-NS-■-□	3-shelf
<b>TECHNICIAN CART (35 1/2" H)</b>	
MSCA2/35-NS-■-□	2-shelf
MSCA3/35-NS-■-□	3-shelf



**NS TECHNICIAN CARTS (17 1/2" W X 26" D) WITH DRAWERS**

PART NO.	DESCRIPTION	DRAWER SIZES
<b>TECHNICIAN CART (31 1/2" H)</b>		
MSCA2/35-NS320-■-□	1 drawer	7"
MSCA2/31-NS220-■-□	2 drawers	(2) 3"
MSCA2/31-NS221-■-□	3 drawers	(1) 2", (1) 4"

**TECHNICIAN CART (35 1/2" H)**

MSCA2/35-NS320-■-□	2 drawers	(2) 5"
MSCA2/35-NS321-■-□	2 drawers	(1) 3", (1) 7"
MSCA2/35-NS322-■-□	2 drawers	(1) 3", (1) 7"
MSCA2/35-NS330-■-□	3 drawers	(3) 3"
MSCA2/35-NS331-■-□	3 drawers	(2) 2", (1) 5"
MSCA2/35-NS332-■-□	3 drawers	(1) 2", (1) 3", (1) 4"
MSCA2/35-NS340-■-□	4 drawers	(4) 2"

\*Drawers are full extension, 165 lb. capacity, with 12" wide x 18" deep usable inside drawer dimensions



**ST TECHNICIAN CARTS (31 3/4" W X 23" D X 35 1/2" H) SHELF ONLY**

PART NO.	DESCRIPTION
MSCA2/35-ST-■-□	2-shelf
MSCA3/35-ST-■-□	3-shelf

**ST TECHNICIAN CART (31 3/4" W X 23" D X 35 1/2" H) WITH DRAWERS**

PART NO.	DESCRIPTION	DRAWER SIZES
MSCA2/35-ST320-■-□	2 drawers	(2) 5"
MSCA2/35-ST321-■-□	2 drawers	(1) 3", (1) 7"
MSCA2/35-ST322-■-□	2 drawers	(1) 4", (1) 6"
MSCA2/35-ST330-■-□	3 drawers	(3) 3"
MSCA2/35-ST331-■-□	3 drawers	(2) 2", (1) 5"
MSCA2/35-ST332-■-□	3 drawers	(1) 2", (1) 3", (1) 4"
MSCA2/35-ST340-■-□	4 drawers	(4) 2"

\*Drawers are full extension, 440 lb. capacity, with 24" wide x 18" deep usable inside drawer dimensions

### 3. BULK STORAGE CABINETS

#### BULK 3 DRAWER STORAGE CABINETS - 750 MODELS (33.46" H)

■ Select: Base ■ Select: Lock □ Select: Paint Color



NW0750-0318 ■ ■ □ 16.85"W x 28.54"D



MP0750-0318 ■ ■ □ 22.2"W x 28.54"D



SC0750-0318 ■ ■ □ 28.23"W x 28.54"D



EW0750-0318 ■ ■ □ 34.25"W x 28.54"D



HW0750-0318 ■ ■ □ 40.28"W x 28.54"D



MW0750-0318 ■ ■ □ 46.97"W x 28.54"D



DW0750-0318 ■ ■ □ 56.34"W x 28.54"D

#### BULK 3 SHELF STORAGE CABINETS - 750 MODELS (33.46" H)

Each Cabinet includes 1 bottom and 2 adjustable shelves

■ Select: Base ■ Select: Lock □ Select: Paint Color



NW0750-0309 ■ ■ □ (RIGHT)  
NW0750-0310 ■ ■ □ (LEFT)  
16.85"W x 28.54"D



MP0750-0309 ■ ■ □ (RIGHT)  
MP0750-0310 ■ ■ □ (LEFT)  
22.2"W x 28.54"D



SC0750-0309 ■ ■ □ (RIGHT)  
SC0750-0310 ■ ■ □ (LEFT)  
28.23"W x 28.54"D



EWHD750 ■ ■ □ 34.25"W x 28.54"D



HWHD750 ■ ■ □ 40.28"W x 28.54"D



MWHD750 ■ ■ □ 46.97"W x 28.54"D



DWHD750 ■ ■ □ 56.34"W x 28.54"D



## 3. HOSE REEL STORAGE CABINETS

### HOSE REEL STORAGE CABINETS - 750 MODELS (33.46" H)

■ Select: Base ■ Select: Lock □ Select: Paint Color



NWPFD750/HR1 ■ ■ □  
16.85"W x 28.54"D



MPPFD750/HR2 ■ ■ □  
22.2"W x 28.54"D



SCPFD750/HR2 ■ ■ □  
28.23"W x 28.5D



EWPSD750/HR3 ■ ■ □  
34.25"W x 28.54"D



HWPSD750/HR4 ■ ■ □  
40.28"W x 28.54"D



MWPSD750/HR4 ■ ■ □  
46.97"W x 28.54"D



DWPSD750/HR4 ■ ■ □  
56.34"W x 28.54"D

## TECHNICIAN SERIES TOOLBOXES - 750 MODELS (33.46" H)

(SEE PAGES 28-29 FOR AVAILABLE 750 MODELS)



750 Series

## 2. SINGLE SERVICE BAYS - 900 SERIES

■ Select: Lock □ Select: Paint Color

**EXAMPLE:** to order a black **ST0750-SL210I** cabinet with 2" leveling base and no lock, the part ordering number would be **ST0750-SL210I-2LB-NL-BK**.



**TSB900SF01LB2** 61.4"W X 31.17"D X 45.96 H"

**COMPONENTS**

- MP0900-WRC-2LB  Cabinet, Waste/Recycle
- NS0900-\_\_\_\_-2LB  Cabinet, Lift Control \_\_\_\_ Pump
- MP0900-0416FV-2LB  Bulk 4 Drawer Cabinet
- SST29.0X061.4/ELUO Stainless Steel worktop w/integrated power



**TSB900SF02LB2** 62.5"W X 31.17"D X 45.96 H"

**COMPONENTS**

- MP900CG-X-2LB  Garage, Mobile Cart
- NS0900-\_\_\_\_-2LB  Cabinet, Lift Control \_\_\_\_ Pump
- MP0900-0416FV-2LB  Bulk 4 Drawer Cabinet
- SST29.0X061.4/ELUO Stainless Steel worktop w/integrated power



**TSB900SF04LB2** 61.4"W X 31.17"D X 45.96 H"

**COMPONENTS**

- MP0900-WRC-2LB  Cabinet, Waste/Recycle
- HW0900-0416FV-2LB  Bulk 4 Drawer Cabinet
- SST29.0X062.5/ELUO Stainless Steel worktop w/integrated power

## 2. DOUBLE SERVICE BAYS - 900 SERIES

■ Select: Lock □ Select: Paint Color



**TSB900DF01LB2** 100.6"W X 31.17"D X 45.96 H"

**COMPONENTS**

- MP0900-0416FV-2LB  Bulk 4 Drawer Cabinet
- NS0900-\_\_\_\_-2LB  Cabinet, Lift Control \_\_\_\_ Pump
- MP0900-WRC-2LB  Cabinet, Waste/Recycle
- NS0900-\_\_\_\_-2LB  Cabinet, Lift Control \_\_\_\_ Pump
- MP0900-0416FV-2LB  Bulk 4 Drawer Cabinet
- SST29.0X100.6/EBUO Stainless Steel worktop w/integrated power



**TSB900DF02LB2** 108.9"W X 31.17"D X 45.96 H"

**COMPONENTS**

- MP0900-0416FV-2LB  Bulk 4 Drawer Cabinet
- MP900CG-X-2LB  Garage, Mobile Cart
- ST0900-\_\_\_\_-2LB  Cabinet, Lift Control \_\_\_\_ Pump
- MP900CG-X-2LB  Garage, Mobile Cart
- MP0900-0416FV-2LB  Bulk 4 Drawer Cabinet
- SST29.0X117.3/EBUO Stainless Steel worktop w/integrated power



**TSB900DF04LB2** 117.3"W X 31.17"D X 45.96 H"

**COMPONENTS**

- HW0900-0416FV-2LB  Bulk 4 Drawer Cabinet
- SC0900-WRC-2LB  Cabinet, Waste/Recycle
- HW0900-0416FV-2LB  Bulk 4 Drawer Cabinet
- SST29.0X108.9/EBUO Stainless Steel worktop w/integrated power

## 3. CART GARAGES 900 (39.37" H)

### CART GARAGES FOR MOBILE CARTS

■ Select: Base ■ Select: Lock □ Select: Paint Color

See page 17 for mobile carts



**MP900CG-X**    22.2"W x 28.54"D



**SC900CG-X**    28.23"W x 28.54"D





Replace "X" with  
L for left hand hinged door  
R for right hand hinged door (shown)

# VEHICLE SERVICES

## 3. LIFT CONTROL CABINETS 900 (39.37" H) ROTARY LIFT CONTROL CABINETS



■ Select: Base ■ Select: Lock □ Select: Paint Color

EXAMPLE: to order a black ST0750-SL210I cabinet with 2" leveling base and no lock, the part ordering number would be ST0750-SL210I-2LB-NL-BK.

SL210I		SL210		SHOCKWAVE
SINGLE	DOUBLE	SINGLE	DOUBLE	SINGLE
				
NS0900-SL210I-■-■-□ 16.85"W x 22.52"D	ST0900-210I-■-■-□ 28.23"W x 22.52"D	NS0900-SL210-■-■-□ 16.85"W x 22.52"D	ST0900-210-■-■-□ 28.23"W x 22.52"D	MP0900-SWP-■-■-□ 22.2"W x 28.54"D
CL0900-SL210I-■-■-□ 22.2"W x 22.52"D		CL0900-SL210-■-■-□ 22.2"W x 22.52"D		

## CHALLENGER LIFT CONTROL CABINETS

■ Select: Base ■ Select: Lock □ Select: Paint Color

CS1020WVBM	
SINGLE	DOUBLE
	
NS0900-CBMC-■-■-□ 16.85"W x 22.52"D	ST0900-CBMC-■-■-□ 28.23"W x 22.52"D
CL0900-CBMC-■-■-□ 22.2"W x 22.52"D	



## 3. WASTE RECEPTACLE CABINETS 900 (39.37" H)

■ Select: Base ■ Select: Lock □ Select: Paint Color

		
NW0900-WRC-■-■-□ 16.85"W x 28.54"D	MP0900-WRC-■-■-□ 22.2"W x 28.54"D	SC0900-WRC-■-■-□ 28.23"W x 28.54"D



900 Series

### 3. SERVICE BAY BULK STORAGE CABINETS

#### BULK 4 DRAWER STORAGE CABINETS - 900 MODELS (39.37" H)

■ Select: Base ■ Select: Lock □ Select: Paint Color



NW0900-0416-■-■-□  
16.85"W x 28.54"D



MP0900-0416-■-■-□  
22.2"W x 28.54"D



SC0900-0416-■-■-□  
28.23"W x 28.54"D



EW0900-0416-■-■-□  
34.25"W x 28.54"D



HW0900-0416-■-■-□  
40.28"W x 28.54"D



MW0900-0416-■-■-□  
46.97"W x 28.54"D



DW0900-0416-■-■-□  
56.34"W x 28.54"D

#### BULK 3 SHELF STORAGE CABINETS - 900 MODELS (39.37" H)

■ Select: Base ■ Select: Lock □ Select: Paint Color

Each Cabinet includes 1 bottom and 2 adjustable shelves



NW0900-0306-■-■-□ (RIGHT)  
NW0900-0307-■-■-□ (LEFT)  
16.85"W x 28.54"D



MP0900-0306-■-■-□ (RIGHT)  
MP0900-0307-■-■-□ (LEFT)  
22.2"W x 28.54"D



SC0900-0306-■-■-□ (RIGHT)  
SC0900-0307-■-■-□ (LEFT)  
28.23"W x 28.54"D



EWHD900-■-■-□  
34.25"W x 28.54"D



HWHD900-■-■-□  
40.28"W x 28.54"D



MWHD900-■-■-□  
46.97"W x 28.54"D



DWHD900-■-■-□  
56.34"W x 28.54"D



## 3. HOSE REEL STORAGE CABINETS

### HOSE REEL STORAGE CABINETS - 900 MODELS (39.37" H)

■ Select: Base ■ Select: Lock □ Select: Paint Color



NWPFD900/HR1-■-■-□  
16.85"W x 28.54"D



MPPFD900/HR2-■-■-□  
22.2"W x 28.54"D



SCPFD900/HR2-■-■-□  
28.23"W x 28.54"D



EWPSD900/HR3-■-■-□  
34.25"W x 28.54"D



HWPSD900/HR4-■-■-□  
40.28"W x 28.54"D



MWPSD900/HR4-■-■-□  
46.97"W x 28.54"D



DWPSD900/HR4-■-■-□  
56.34"W x 28.54"D

## TECHNICIAN SERIES TOOLBOXES - 900 MODELS (39.37" H)

(SEE PAGES 30-31 FOR AVAILABLE 900 MODELS)



900 Series

## SERVICE BAY GARAGE CABINETS: FULL DEPTH

■ Select: Base ■ Select: Lock □ Select: Paint Color



FOOTPRINTS (WxD)		NW 16.85"X 28.54"		MP 22.2"X 28.54"		SC 28.23"X 28.54"	
Model	Height	Part No.	Cu. In.	Part No.	Cu. In.	Part No.	Cu. In.
750	33.46"	NW750CG-X-■-■-□	10,400	MP750CG-X-■-■-□	14,235	SC750CG-X-■-■-□	18,548
900	39.37"	NW900CG-X-■-■-□	12,480	MP900CG-X-■-■-□	17,082	SC900CG-X-■-■-□	22,258
1050	45.28"	NW1050CG-X-■-■-□	14,561	MP1050CG-X-■-■-□	19,928	SC1050CG-X-■-■-□	25,967
1200	51.18"	NW1200CG-X-■-■-□	16,641	MP1200CG-X-■-■-□	22,775	SC1200CG-X-■-■-□	29,677
1350	57.09"	NW1350CG-X-■-■-□	18,721	MP1350CG-X-■-■-□	25,622	SC1350CG-X-■-■-□	33,387
1500	62.99"	NW1500CG-X-■-■-□	20,801	MP1500CG-X-■-■-□	28,469	SC1500CG-X-■-■-□	37,096

Replace "X" with  
**L** for left hand hinged door  
**R** for right hand hinged door (shown)

## SERVICE BAY GARAGE CABINETS: SHALLOW DEPTH

■ Select: Base ■ Select: Lock □ Select: Paint Color



FOOTPRINTS (WXD)		NS 16.85"X 22.52"		CL 22.2"X 22.52"		ST 28.23"X 22.52"	
Model	Height	Part No.	Cu. In.	Part No.	Cu. In.	Part No.	Cu. In.
750	33.46"	NS750CG-X-■-■-□	7,817	CL750CG-X-■-■-□	10,699	ST750CG-X-■-■-□	13,941
900	39.37"	NS900CG-X-■-■-□	9,381	CL900CG-X-■-■-□	12,839	ST900CG-X-■-■-□	16,729
1050	45.28"	NS1050CG-X-■-■-□	10,944	CL1050CG-X-■-■-□	14,979	ST1050CG-X-■-■-□	19,518
1200	51.18"	NS1200CG-X-■-■-□	12,507	CL1200CG-X-■-■-□	17,119	ST1200CG-X-■-■-□	22,306
1350	57.09"	NS1350CG-X-■-■-□	14,071	CL1350CG-X-■-■-□	19,258	ST1350CG-X-■-■-□	25,094
1500	62.99"	NS1500CG-X-■-■-□	15,634	CL1500CG-X-■-■-□	21,398	ST1500CG-X-■-■-□	27,882

Replace "X" with  
L for left hand hinged door  
R for right hand hinged door (shown)

## TECH SERIES TOOLBOXES – A TECHNICIAN’S DREAM

Your service business’s success depends on your team’s ability to do high-quality, timely work. To do their best work, your technicians need the right tool storage and access for the job. The wrong toolbox can slow productivity and affect job turnaround, resulting in customer dissatisfaction and lost business.

Equip your technicians with Lista® Technician Series toolboxes that are rugged enough to withstand a beating, spacious enough to hold everything they need them to, flexible enough to suit their work style, and organized for maximum efficiency. They’re the best quality tool storage you can get your hands on – at the best price.

### WITH LISTA, YOU GET IT ALL – THE LARGEST CAPACITY, MOST DURABLE BOXES ON THE MARKET, AT A PRICE THAT BOXES OUT THE COMPETITION.

Compare our features and you’ll see the difference:

- Rugged design backed by limited lifetime warranty
- Fully welded drawer and housing construction
- Heavy-duty casters (1,200 lbs. each)
- 440 lb. capacity full-extension drawers
- Sub-dividable drawers
- Twelve standard drawer heights available from 2" - 13"
- Multiple full-width configurations
- Premium non-slip mesh drawer liners
- Five standard gloss finish powder coated colors, with two-tone color schemes available
- Drawer pull finish options enhance appearance and add style

**Includes central lock with keyed-alike capability for multiple units**

**All mobile units include side push handle**

**Drawer handles are flush with housing so clothing won’t snag**

**Drawer compartments for bulk storage**

**Total lock break on swivel casters in mobile configurations**

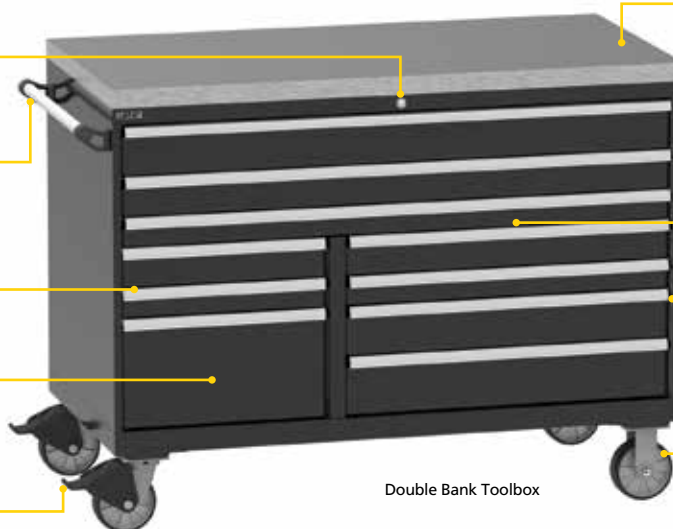

Double Bank Toolbox

**Available in a variety of work surfaces**

**All drawers are full extension with 440 lb. capacity**

**PreventTip® safety system**

**Mobile units include individual drawer latches for safe transport**

**Most models available in either mobile or stationary configuration**



## How to order a Preconfigured Technician Series Toolbox

1. Select toolbox configuration on pages 28-33.
2. ■ Select base type on page 34.
  - 2LB = 2" Leveling base with stainless steel kick plate
  - 4LB = 4" Leveling base with stainless steel kick plate
  - WC = stationary raised base with stainless steel feet
  - M = mobile base (not recommended for Model 1350)
3. □ Select paint color. For color chart, see page 35
4. Select Drawer handle Pulls (optional see page 35)
5. Select cabinet top or counter top (optional see page 36)
6. Select Drawer Interiors (optional see page 37)

**EXAMPLE:** to order an TSDW0750-0721 toolbox with a mobile base in a Black housing with Red drawers, the part ordering number would be **TSDW0750-0721-MBKG-NRG**. To order a butcher block top for your toolbox, include part number **DW1BCT**.

To custom design your own toolbox, contact your Lista sales representative.

## 1. SELECT TOOLBOX

### DOUBLE BANK TOOLBOX



#### Housing Heights:

750, 900, 1050

#### Housing Widths:

DW Combo Housing (56.5")  
 (Left Bay) MP (Right Bay) EW  
 Total Length with Handle: 60"

#### Depths:

Full (28.5")

### DOUBLE BANK TOOLBOX FOOTPRINTS – AVAILABLE IN 5 HEIGHTS

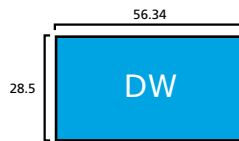

### TRIPLE BANK TOOLBOX



#### Housing Heights:

750, 900, 1050

#### Housing Widths:

DW Combo Housing (56.5")  
 (Left Bay) MP (Right Bay) EW  
 Right Cabinet: MP (22.2")  
 Total length with Handle: 82.25"

#### Depths:

Full (28.5")

### TRIPLE BANK TOOLBOX FOOTPRINTS – AVAILABLE IN 3 HEIGHTS

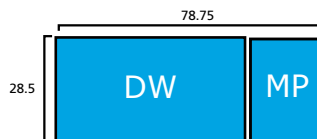

# 1. MODEL 750 DOUBLE BANK TOOLBOXES

## 41½" HIGH MOBILE TOOLBOX\*

(Housing height without base is 33½")

\*other base options also available

- Select from 6 different configurations (With more available at [ListaBox.com](http://ListaBox.com))
- Choice of mobile or stationary bases
- All units include protective ribbed rubber mat on top. Additional top choices available.
- All drawers include premium mesh drawer liner
- Top drawer includes divider and bin tool organization starter kit
- Drawer heights shown in charts indicate usable height of drawer
- All Double Bank drawers are full extension with a **440lb.** capacity
- To custom design your own toolbox, contact your Lista representative

\*\*All orders must include choice of base and color

To complete part number, specify base type ■ and paint color .

See page 60-61 for complete ordering instructions.



TSDW07C04-1101FL-MNRG  
WITH OPTIONAL BUTCHER BLOCK TOP

\*All drawers have 440 lb. weight cap.

**Usable inside drawer dimensions:**

Top bank (DW drawer): 52" W x 24" D

Left bank (MP drawer): 18" W x 24" D

Right bank (EW drawer): 30" W x 24" D

## DOUBLE BANK POPULAR CONFIGURATIONS



11 drawers, including **3 full width drawers**  
56½" wide (60" wide including handle)  
28,570 cubic inches • 8,708 square inches

**PART NO.** TSDW07C04-1101FL-■ **DEPTH** 28½"



10 drawers, including **3 full width drawers**  
56½" wide (60" wide including handle)  
29,142 cubic inches • 7,983 square inches

**PART NO.** TSDW07C04-1003FL-■ **DEPTH** 28½"



10 drawers, including **2 full width drawers**  
56½" wide (60" wide including handle)  
29,560 cubic inches • 7,450 square inches

**PART NO.** TSDW07C04-1002FL-■ **DEPTH** 28½"



9 drawers, including **2 full width drawers**  
56½" wide (60" wide including handle)  
30,132 cubic inches • 6,725 square inches

**PART NO.** TSDW07C04-0901FL-■ **DEPTH** 28½"



12 drawers, including **1 full width drawer**  
56½" wide (60" wide including handle)  
28,723 cubic inches • 7,789 square inches

**PART NO.** TSDW07C06-1201FL-■ **DEPTH** 28½"



11 drawers, including **1 full width drawer**  
56½" wide (60" wide including handle)  
29,065 cubic inches • 7,354 square inches

**PART NO.** TSDW07C06-1102FL-■ **DEPTH** 28½"

# VEHICLE SERVICES

## 1. MODEL 750 TRIPLE BANK TOOLBOXES

### 41½" HIGH MOBILE TOOLBOX\*

(Housing height without base is 33½")

\*other base options also available

- Mobile bases include 4 end swivel and 2 center fixed 6" x 2" heavy-duty casters (1,200 lbs. each) with total lock brakes
- All units include protective ribbed rubber mat on top. Additional top choices available.
- Both locks are keyed-alike
- All drawers include premium mesh drawer liner
- Top drawer includes divider and bin tool organization starter kit
- All Triple Bank drawers are full extension with a **440 lb.** capacity

\*\*All orders must include choice of base and color

To complete part number, specify paint color .

See page 60-61 for complete ordering instructions.



TSTB750-1801-M293  
WITH OPTIONAL Vinyl Mat TOP

Tech Series

All drawers have 440 lb. weight cap.

#### Usable inside drawer dimensions:

Top bank (DW drawer): 52" W x 24" D

Left bank (MP drawer): 18" W x 24" D

Middle bank (EW drawer): 30" W x 24" D

Right bank (MP drawer): 18" W x 24" D

## TRIPLE BANK POPULAR CONFIGURATIONS

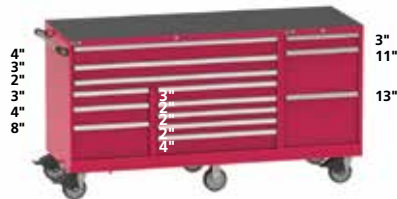

14 drawers, including 3 full width drawers  
78¾" wide (82¼" wide including handle)  
40,398 cubic inches • 10,014 square inches

PART NO. DEPTH  
TSTB750-1401- 28½"

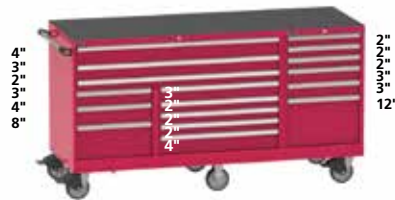

17 drawers, including 3 full width drawers  
78¾" wide (82¼" wide including handle)  
39,370 cubic inches • 11,320 square inches

PART NO. DEPTH  
TSTB750-1702- 28½"



18 drawers, including 3 full width drawers  
78¾" wide (82¼" wide including handle)  
39,027 cubic inches • 11,756 square inches

PART NO. DEPTH  
TSTB750-1801- 28½"



18 drawers, including 3 full width drawers  
78¾" wide (82¼" wide including handle)  
39,256 cubic inches • 11,466 square inches

PART NO. DEPTH  
TSTB750-1802- 28½"

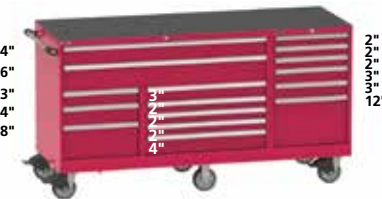

16 drawers, including 2 full width drawers  
78¾" wide (82¼" wide including handle)  
40,360 cubic inches • 10,062 square inches

PART NO. DEPTH  
TSTB750-1601- 28½"



19 drawers, including 1 full width drawer  
78¾" wide (82¼" wide including handle)  
39,179 cubic inches • 10,837 square inches

PART NO. DEPTH  
TSTB750-1901- 28½"

# 1. MODEL 900 DOUBLE BANK TOOLBOXES

## 47<sup>3</sup>/<sub>8</sub>" HIGH MOBILE TOOLBOX\*

(Housing height without base is 39<sup>3</sup>/<sub>8</sub>" )

\*other base options also available

- Select from 6 different configurations (with more available at [ListaBox.com](http://ListaBox.com))
- Choice of mobile or stationary bases
- All units include protective ribbed rubber mat on top. Additional top choices available.
- All drawers include premium mesh drawer liner
- Top drawer includes divider and bin tool organization starter kit
- Drawer heights shown in charts indicate usable height of drawer
- All Double Bank drawers are full extension with a **440 lb.** capacity
- To custom design your own toolbox, contact your Lista representative

\*All orders must include choice of base and color

To complete part number, specify base type  and paint color .

See page 60-61 for complete ordering instructions.



TSDW09C06-1201FL  
WITH OPTIONAL VINYL MAT TOP

\*All drawers have 440 lb. weight cap.  
**Usable inside drawer dimensions:**  
Top bank (DW drawer): 52" W x 24" D  
Left bank (MP drawer): 18" W x 24" D  
Right bank (EW drawer): 30" W x 24" D

## DOUBLE BANK POPULAR CONFIGURATIONS



14 drawers, including 3 full width drawers  
56<sup>1</sup>/<sub>2</sub>" wide (60" wide including handle)  
34,170 cubic inches • 10,305 square inches

PART NO. TSDW09C06-1401FL- DEPTH 28<sup>1</sup>/<sub>2</sub>"



13 drawers, including 3 full width drawers  
56<sup>1</sup>/<sub>2</sub>" wide (60" wide including handle)  
34,513 cubic inches • 9,870 square inches

PART NO. TSDW09C06-1303FL- DEPTH 28<sup>1</sup>/<sub>2</sub>"



13 drawers, including 2 full width drawers  
56<sup>1</sup>/<sub>2</sub>" wide (60" wide including handle)  
35,161 cubic inches • 9,047 square inches

PART NO. TSDW09C06-1302FL- DEPTH 28<sup>1</sup>/<sub>2</sub>"



12 drawers, including 2 full width drawers  
56<sup>1</sup>/<sub>2</sub>" wide (60" wide including handle)  
35,503 cubic inches • 8,611 square inches

PART NO. TSDW09C06-1201FL- DEPTH 28<sup>1</sup>/<sub>2</sub>"



15 drawers, including 1 full width drawer  
56<sup>1</sup>/<sub>2</sub>" wide (60" wide including handle)  
34,094 cubic inches • 9,676 square inches

PART NO. TSDW09C07-1501FL- DEPTH 28<sup>1</sup>/<sub>2</sub>"



14 drawers, including 1 full width drawer  
56<sup>1</sup>/<sub>2</sub>" wide (60" wide including handle)  
34,665 cubic inches • 8,950 square inches

PART NO. TSDW09C07-1402FL- DEPTH 28<sup>1</sup>/<sub>2</sub>"



## 1. MODEL 900 TRIPLE BANK TOOLBOXES

### 47<sup>3</sup>/<sub>8</sub>" HIGH MOBILE TOOLBOX\*

(Housing height without base is 39<sup>3</sup>/<sub>8</sub>" )

\*other base options also available

- Choice of mobile or stationary bases
- Mobile bases include 4 end swivel and 2 center fixed 6" x 2" heavy-duty casters (1,200 lbs. each) with total lock brakes
- All units include protective ribbed rubber mat on top. Additional top choices available.
- Both locks are keyed-alike
- All drawers include premium mesh drawer liner
- Top drawer includes divider and bin tool organization starter kit
- All Triple Bank drawers are full extension with a 440 lb. capacity

\*All orders must include choice of base and color

To complete part number, specify paint color .

See page 60-61 for complete ordering instructions.



TSTB900-2001-M5003  
WITH OPTIONAL VINYL MAT TOP

All drawers have 440 lb. weight cap.

**Usable inside drawer dimensions:**

Top bank (DW drawer): 52" W x 24" D

Left bank (MP drawer): 18" W x 24" D

Middle bank (EW drawer): 30" W x 24" D

Right bank (MP drawer): 18" W x 24" D

## TRIPLE BANK POPULAR CONFIGURATIONS



22 drawers, including 3 full width drawers  
78<sup>3</sup>/<sub>4</sub>" wide (82<sup>1</sup>/<sub>4</sub>" wide including handle)  
46,855 cubic inches • 13,789 square inches

PART NO. DEPTH  
TSTB900-2202- 28<sup>1</sup>/<sub>2</sub>"



22 drawers, including 3 full width drawers  
78<sup>3</sup>/<sub>4</sub>" wide (82<sup>1</sup>/<sub>4</sub>" wide including handle)  
46,855 cubic inches • 13,788 square inches

PART NO. DEPTH  
TSTB900-2201- 28<sup>1</sup>/<sub>2</sub>"

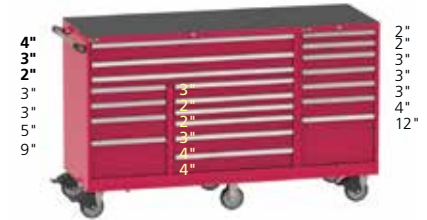

21 drawers, including 3 full width drawers  
78<sup>3</sup>/<sub>4</sub>" wide (82<sup>1</sup>/<sub>4</sub>" wide including handle)  
47,198 cubic inches • 13,353 square inches

PART NO. DEPTH  
TSTB900-2102- 28<sup>1</sup>/<sub>2</sub>"



18 drawers, including 3 full width drawers  
78<sup>3</sup>/<sub>4</sub>" wide (82<sup>1</sup>/<sub>4</sub>" wide including handle)  
48,226 cubic inches • 12,047 square inches

PART NO. DEPTH  
TSTB900-1801- 28<sup>1</sup>/<sub>2</sub>"



20 drawers, including 2 full width drawers  
78<sup>3</sup>/<sub>4</sub>" wide (82<sup>1</sup>/<sub>4</sub>" wide including handle)  
48,189 cubic inches • 12,095 square inches

PART NO. DEPTH  
TSTB900-2001- 28<sup>1</sup>/<sub>2</sub>"



23 drawers, including 1 full width drawer  
78<sup>3</sup>/<sub>4</sub>" wide (82<sup>1</sup>/<sub>4</sub>" wide including handle)  
47,007 cubic inches • 12,869 square inches

PART NO. DEPTH  
TSTB900-2301- 28<sup>1</sup>/<sub>2</sub>"

# 1. MODEL 1050 DOUBLE BANK TOOLBOXES

## 53 3/4" high mobile toolbox\*

\*other base options also available

(housing height without base is 45 1/4")

- Select from 6 different configurations (with more available at [ListaBox.com](http://ListaBox.com))
- Choice of mobile or stationary bases
- All units include protective ribbed rubber mat on top. Additional top choices available.
- All drawers include premium mesh drawer liner
- Top drawer includes divider and bin tool organization starter kit
- Drawer heights shown in charts indicate usable height of drawer
- All Double Bank drawers are full extension with a **440 lb.** capacity
- To custom design your own toolbox, contact your Lista representative

\*All orders must include choice of base and color

To complete part number, specify base type  and paint color . See page 60-61 for complete ordering instructions.



TSDW10C07-1502FL-M12179  
WITH OPTIONAL VINYL MAT TOP

\*All drawers have 440 lb. weight cap.  
Usable inside drawer dimensions:  
Top bank (DW drawer): 52" W x 24" D  
Left bank (MP drawer): 18" W x 24" D  
Right bank (EW drawer): 30" W x 24" D

## DOUBLE BANK POPULAR CONFIGURATIONS



16 drawers, including 3 full width drawers  
56 1/2" wide (60" wide including handle)  
40,113 cubic inches • 11,466 square inches

PART NO. TSDW10C07-1601FL- DEPT 28 1/2"



15 drawers, including 3 full width drawers  
56 1/2" wide (60" wide including handle)  
40,455 cubic inches • 11,030 square inches

PART NO. TSDW10C07-1503FL- DEPTH 28 1/2"



15 drawers, including 2 full width drawers  
56 1/2" wide (60" wide including handle)  
41,103 cubic inches • 10,208 square inches

PART NO. TSDW10C07-1502FL- DEPTH 28 1/2"



14 drawers, including 2 full width drawers  
56 1/2" wide (60" wide including handle)  
41,446 cubic inches • 9,773 square inches

PART NO. TSDW10C07-1401FL- DEPTH 28 1/2"



17 drawers, including 1 full width drawer  
56 1/2" wide (60" wide including handle)  
40,265 cubic inches • 10,547 square inches

PART NO. TSDW10C09-1701FL- DEPTH 28 1/2"



16 drawers, including 1 full width drawer  
56 1/2" wide (60" wide including handle)  
40,608 cubic inches • 10,111 square inches

PART NO. TSDW10C09-1602FL- DEPTH 28 1/2"

## 1. MODEL 1050 TRIPLE BANK TOOLBOXES

### 53¼" high mobile toolbox\*

\*other base options also available

(housing height without base is 45¼")

- Choice of mobile or stationary bases
- Mobile bases include 4 end swivel and 2 center fixed 6" x 2" heavy-duty casters (1,200 lbs. each) with total lock brakes
- All units include protective ribbed rubber mat on top. Additional top choices available.
- Both locks are keyed-alike
- All drawers include premium mesh drawer liner
- Top drawer includes divider and bin tool organization starter kit
- All Triple Bank drawers are full extension with a **440 lb.** capacity

\*All orders must include choice of base and color

To complete part number, specify paint color .

See page 60-61 for complete ordering instructions.



TSTB1050-2501-MBLK  
WITH OPTIONAL VINYL MAT TOP

All drawers have 440 lb. weight cap.

**Usable inside drawer dimensions:**

- Top bank (DW drawer): 52" W x 24" D
- Left bank (MP drawer): 18" W x 24" D
- Middle bank (EW drawer): 30" W x 24" D
- Right bank (MP drawer): 18" W x 24" D

## TRIPLE BANK POPULAR CONFIGURATIONS



25 drawers, including 3 full width drawers  
78¾" wide (82¼" wide including handle)  
55,027 cubic inches • 15,385 square inches

PART NO. TSTB1050-2501- DEPTH 28½"



25 drawers, including 3 full width drawers  
78¾" wide (82¼" wide including handle)  
55,026 cubic inches • 15,384 square inches

PART NO. TSTB1050-2502- DEPTH 28½"



24 drawers, including 3 full width drawers  
78¾" wide (82¼" wide including handle)  
55,369 cubic inches • 14,949 square inches

PART NO. TSTB1050-2402- DEPTH 28½"



22 drawers, including 3 full width drawers  
78¾" wide (82¼" wide including handle)  
56,055 cubic inches • 14,078 square inches

PART NO. TSTB1050-2201- DEPTH 28½"



23 drawers, including 2 full width drawers  
78¾" wide (82¼" wide including handle)  
56,359 cubic inches • 13,691 square inches

PART NO. TSTB1050-2301- DEPTH 28½"



26 drawers, including 1 full width drawer  
78¾" wide (82¼" wide including handle)  
55,179 cubic inches • 14,465 square inches

PART NO. TSTB1050-2601- DEPTH 28½"



## 2. SELECT BASE

(OPTIONAL)

### LEVELING BASE

Allows for quick and easy leveling from inside of cabinet. Includes a front cover that adjusts as cabinet is leveled. Base is available in multiple heights in cold-rolled, galvanealed steel with matching covers or stainless steel cover option. Adjustment tool, side skirts, anchor kit and glide cap kit are also available.



Height added to housing height: **2" (2LB)**  
**4" (4LB)**

### WET CLEAN BASE (WC)

Allows for easy cleaning below housing in areas where floors are often washed (such as labs and hospitals), or where wet floors are an issue. Raises cabinet housing 4 9/16" above floor. Individual leg height is further adjustable to allow for leveling (up to 1 3/4" additional height), even on extremely uneven surfaces. Cabinet can be lifted and moved with a hand pallet truck.



Height added to housing height: **4 1/2" - 6 1/4"**

### MOBILE CASTER BASE (M)

Mobile base – 2 fixed and 2 swivel 6" x 2" heavy-duty casters (1,200 lbs. each) with total lock brakes. Triple bank and two-bay mobile bases have 4 end swivel and 2 center fixed 6" x 2" heavy-duty casters (1,200 lbs. each) with total lock brakes



Height added to housing height: **8"**





## 3. SELECT PAINT COLOR(S)

### TECH SERIES TOOLBOX COLORS



**CODE COLOR**  
239 Blaze Blue



**CODE COLOR**  
5003 Dusk Blue

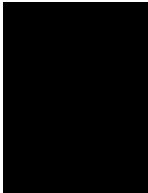

**CODE COLOR**  
BKG Black



**CODE COLOR**  
NRG Red



**CODE COLOR**  
12179 Yellow



Tech Series

Note: Paint colors have a premium gloss finish.

## 4. SELECT DRAWER HANDLE PULLS

### DRAWER HANDLE PULLS (OPTIONAL)

For those not requiring labeling of drawers or contents aluminum extruded covers are available in three finishes including: gloss black, chrome color, and brushed silver.



### UPGRADE PART NUMBERS (REPLACES SCRIPT HANDLE COVER)

STYLE WIDTH	COLORS		
	BRUSHED SILVER	CHROME COLOR	GLOSS BLACK
	PART NO.	PART NO.	PART NO.
CL/MP	HNDL-CLMP/BRSH	HNDL-CLMP/CHRM	HNDL-CLMP/GBLK
ES/EW	HNDL-ESEW/BRSH	HNDL-ESEW/CHRM	HNDL-ESEW/GBLK
HT/DW	HNDL-HTDW/BRSH	HNDL-HTDW/CHRM	HNDL-HTDW/GBLK

## 5. SELECT CABINET TOP OR COUNTER TOP (OPTIONAL)

### BUTCHER BLOCK CABINET TOPS

Tops are satin finish 1 3/4" thick hardwood and are flush to the cabinet side-to-side and front-to-back.



### STAINLESS STEEL CABINET COVERS

Cover is constructed of durable, heavy gauge stainless steel. Fits over top and sides of cabinet, and provides easy access to locking system. Adds 1/16" to overall cabinet height and 1/8" to overall width and depth.



### STAINLESS STEEL OVER WOOD CORE (SS)

Worksurface is constructed of durable heavy gauge, 304 stainless steel cover, fitted over top and sides of wood core, 1 13/16" thick.



### WORK TOP OPTIONS

SIZE	DIMENSIONS	STAINLESS STEEL TOP	STAINLESS STEEL COVER	BUTCHER BLOCK
DW	56 1/2" x 28 1/2"	DW1LSSCT	DW1SSC	DW1BCT
TSTB / TS-DWMP	78 3/4" x 28 1/2"	LSSCT-DWMP	SSC-DWMP	BCT-DWMP

## 6. SELECT DRAWER INTERIORS (OPTIONAL)

**CUSTOMIZE YOUR TOOLBOX DRAWER INTERIORS. SUBDIVIDE YOUR DRAWERS FOR ULTIMATE FLEXIBILITY IN TOOL STORAGE.**

Toolbox drawers come standard with mesh drawer liners, and the top drawer of each toolbox includes a starter compartment divider kit. If you prefer to separate your tools within the other drawers, choose from the configurations shown below. Be sure to match drawer interior with correct drawer model and height.

### ■ Select: Drawer Height

75, 100, 150, 200, 250, 300

### How to order drawer interiors

To order the drawer interior sets shown on this page, use the part number in the chart and add the drawer height in place of the green box.

**EXAMPLE:** to order an MPDR206 drawer interior set for a 100 height (3") drawer, the part ordering number would be **MPDR206-100**.

*\*All toolboxes include one drawer divider starter kit. Your toolbox comes equipped with a DWDR516 divider starter kit in the top drawer.*

### EW DRAWERS



For all drawer heights  
PART NO. DRAWER INSIDE DIM.  
EWDR104-■ EW 30" x 24"



For all drawer heights  
PART NO. DRAWER INSIDE DIM.  
EWDR207-■ EW 30" x 24"



For 2" - 7" high drawers only\*  
PART NO. DRAWER INSIDE DIM.  
EWDR310-■ EW 30" x 24"

### MP DRAWERS



For 2" high drawers only  
PART NO. DRAWER INSIDE DIM.  
MPDR028-■ MP 18" x 24"



For 2" and 3" high drawers only  
PART NO. DRAWER INSIDE DIM.  
MPDR018-■ MP 18" x 24"



For all drawer heights  
PART NO. DRAWER INSIDE DIM.  
MPDR103-■ MP 18" x 24"



For all drawer heights  
PART NO. DRAWER INSIDE DIM.  
MPDR104-■ MP 18" x 24"

### DW DRAWERS



For all drawer heights  
PART NO. DRAWER INSIDE DIM.  
DWDR309-■ DW 52" x 24"



For all drawer heights  
PART NO. DRAWER INSIDE DIM.  
DWDR413-■ DW 52" x 24"



For 2" - 7" high drawers only\*  
PART NO. DRAWER INSIDE DIM.  
DWDR516-■ DW 52" x 24"



For 2" - 7" high drawers only\*  
PART NO. DRAWER INSIDE DIM.  
DWDR619-■ DW 52" x 24"

## SERVICE BAYS & SEATING THAT WORK FOR YOU

Unlike your average run-of-the-mill workbenches that don't conform to your specific space and pace, Lista® service bays are custom configured to help your technicians work their best. With a range of drawer sizes, bases, work surfaces, overhead hanging cabinets and accessories, the configuration possibilities are endless – so you get what you want how you want it.



## SEATING SOLUTIONS

And of course, we've got the seating solutions to support your technicians all day long. Built to withstand the most rugged environments, our new industrial seating line keeps your technicians ergonomically-positioned and comfortable for hour-after-hour support on the job.



### **MULTI-PURPOSE STOOL:**

Dual-purpose design works with desks and workbenches



### **SIT-STAND STOOL:**

Adjustable seat height supports proper ergonomic positioning



### **SIT-STAND:**

Adjustable backrest and seat height properly position workers for ergonomic comfort



### **TROLLEY:**

Stool adjusts to desired height and stores easily in rugged environments



## E-SERIES STORAGE SOLUTIONS

THE NEW VIDMAR E-SERIES MAKES ORGANIZING EFFORTLESS. THIS LINE OF CARTS AND CABINETS FEATURES LIGHTER WEIGHT SOLUTIONS, WITH BETTER MOBILITY - AT A LOWER PRICE.

### EASY, ERGONOMIC, ECONOMICAL, EFFICIENT

**Easy:** Product arrives fully assembled and ready for use!

**Ergonomic:** Light weight for easier customer use and increased mobility

**Economical:** Quality and convenience at a low cost price

**Efficient:** Each cabinet comes pre-configured with a single part number for easy ordering. Just select your color option and we will do the rest!



Seating & E-Series

### BACKED BY A LIFETIME GUARANTEE

#### 50" WORKSTATION

Heavy duty locks with tubular key

Recessed extruded aluminum drawer pulls

100% Full extension drawers

Vinyl top and drawer liners included

6" x 2" Polyurethane casters



Part #	Color	# of Drawers	Drawer Capacity (ea.)	Casters Capacity (ea.)	Weight	Dimensions	Static Load Capacity	Total Cubic Capacity
VJ455041-10BK	Black	10	125 lbs.	700 lbs.	475 lbs.	41"H x 50"W x 25"D	2,800 lbs.	23,779
VJ455041-10GY	Grey	10	125 lbs.	700 lbs.	475 lbs.	41"H x 50"W x 25"D	2,800 lbs.	23,779

#### 41" WORKSTATION

Recessed extruded aluminum drawer pulls

100% Full extension drawers

Vinyl top and drawer liners included

Heavy duty easy grip handle

5" x 2" Polyurethane casters



Part #	Color	# of Drawers	Drawer Capacity (ea.)	Casters Capacity (ea.)	Weight	Dimensions	Static Load Capacity	Total Cubic Capacity
VJ444142-15BK	Black	15	100 lbs.	450 lbs.	275 lbs.	42"H x 41"W x 18"D	1,800 lbs.	14,362
VJ444142-15GY	Grey	15	100 lbs.	450 lbs.	275 lbs.	42"H x 41"W x 18"D	1,800 lbs.	14,362



## HEAVY DUTY ROLLER CABINET

Shipped with casters assembled

Aluminum drawer pulls with safety hooks - drawers can't open while moving

Soft bumpers in elastomeric thermoplastic with damper effect shock

Worktop - stamped aluminum reinforced by 15mm wooden board with slots for 16 screwdrivers

Part #	Color	# of Drawers	Drawer Capacity (ea.)	Weight	Dimensions	Static Load Capacity
VJET.6M3B	Black	6	100 lbs.	188 lbs.	30.5"W x 21.5"D x 38"H	2,000 lbs.
VJET.6M3G	Gray	6	100 lbs.	188 lbs.	30.5"W x 21.5"D x 38"H	2,000 lbs.



## LIGHT DUTY ROLLER CABINET

Worktop made of polypropylene with fiber - integrated edges to prevent tools from falling

Resistant to impacts and hydrocarbons

(3) Screwdriver slots built into top

Shipped with casters assembled

Part #	Color	# of Drawers	Drawer Capacity (ea.)	Weight	Dimensions	Static Load Capacity
VROLL.6M3B	Black	6	100 lbs.	118 lbs.	29.5"W x 20"D x 38"H	1,550 lbs.
VROLL.6M3G	Gray	6	100 lbs.	118 lbs.	29.5"W x 20"D x 38"H	1,550 lbs.



## 27" ROLLER CABINET

Recessed extruded aluminum drawer pulls

100% Full extension drawers

Vinyl top and drawer liners included

Heavy duty easy grip handle

5" x 2" Polyurethane casters

Part #	Color	# of Drawers	Drawer Capacity (ea.)	Casters Capacity (ea.)	Weight	Dimensions	Static Load Capacity	Total Cubic Capacity
VJ442735-7-BK	Black	7	100 lbs.	450b lbs.	175 lbs.	35"H x 27"W x 18"D	1,800 lbs.	7,449
VJ442735-7-GY	Gray	7	100 lbs.	450b lbs.	175 lbs.	35"H x 27"W x 18"D	1,800 lbs.	7,449

## HEAVY DUTY UTILITY CART

Made of industrial strength 14, 16 and 18 gauge steel  
 Ergonomic metal side mount handle for easy gripping and handling  
 Adjustable drawer detents ensure drawers stay shut when the box is unlocked  
 Lift up and slide back work top  
 Bottom drawer has 200 lb. capacity



Part #	Color	# of Drawers	Drawer Capacity (ea.)	Casters Capacity (ea.)	Weight	Dimensions	Static Load Capacity	Total Cubic Capacity
VJ559000-3BK	Black	3	125 lbs. - 200 lbs.	900 lbs.	375 lbs.	46" H x 30"W x 23"D	1,600 lbs.	24,450
VJ559000-3GY	Gray	3	125 lbs. - 200 lbs.	900 lbs.	375 lbs.	46" H x 30"W x 23"D	1,600 lbs.	24,450

## MODULAR UTILITY CART

Lift top work surface with (2) gas shocks - 7" deep compartment  
 Fully assembled  
 Pry bar and extension / screwdriver storage  
 6 Outlet power strip



Part #	Color	# of Drawers	Drawer Capacity (ea.)	Casters Capacity (ea.)	Weight	Dimensions	Static Load Capacity	Total Cubic Capacity
VJUC3743-3BK	Black	3	100 lbs.	450 lbs.	231 lbs.	43H x 37W x 20D	1,100 lbs.	20,559
VJUC3743-3GY	Gray	3	100 lbs.	450 lbs.	231 lbs.	43H x 37W x 20D	1,100 lbs.	20,559

## TWO SHELF CART

Basic two shelf system  
 Two 3" deep storage shelves  
 Heavy duty, locking, 5" x 2" casters  
 Reinforced corners for structural support  
 Assembly required



Part #	Color	# of Drawers	Drawer Capacity (ea.)	Casters Capacity (ea.)	Weight	Dimensions	Static Load Capacity	Total Cubic Capacity
VJ441000-BK	Black	-	-	450 lbs.	80 lbs.	38.5H x 37.5W x 20.5D	800 lbs.	-
VJ441000-GY	Gray	-	-	450 lbs.	80 lbs.	38.5H x 37.5W x 20.5D	800 lbs.	-

# VIDMAR® PARTS COUNTERS

**FLEXIBLE. DURABLE. PRECONFIGURED.**

**Durable.** Vidmar modular parts counters are constructed of industrial-grade steel and built tough to handle our customers' toughest jobs. Sturdy Vidmar drawers feature a 440 lb. load capacity.

**Flexible.** Each housing can accept drawers, shelves and roll-out trays so you can customize your counter to your needs. Change, rearrange, or add new drawers, shelves, or roll-outs to your existing counter at any time with ease.

**Preconfigured Counters.** Create independent pods by combining multiple parts counters into long or zig-zag configurations. Counters are 41 1/2" tall for comfortable, ergonomic standing height.

**Storage.** Store fast-moving parts, manuals, and printers conveniently within your parts counter, and even create a lockable cash drawer.

**Lifetime Guarantee.** We stand by the quality of our Vidmar cabinets with our Lifetime Guarantee.

**Zig-Zag Counters.** Give employees their own individual workspace to address their customers.







## PRECONFIGURED PODS

### USE INDEPENDENTLY OR COMBINE THEM TOGETHER

Parts Counters and Behind Counter Cabinets allow you to store up to 80% of picks directly behind the counter for efficient customer handling.

#### 60" LONG X 36" WIDE

2/Parts Drawer Cabinets



1/Parts Drawer Cabinet  
1/Cash Drawer & Shelf Cabinet



Front Display can be either Metal Pegboard with Shelf Option or Slat Board (purchase through your supplier)



1/Parts Drawer Cabinet  
1/Cash or Accessory Drawer with 2-Roll-Out Trays



1/Cash Drawer & Shelf Cabinet  
1/ Shelf Cabinet



#### 90" LONG X 36" WIDE

1/Parts Drawer Cabinet  
1/Roll-Out Tray for Printer  
1/ Cash Drawer & Shelf Cabinet



1/Parts Drawer Cabinet  
1/Shelf Cabinet  
1/Cash Drawer & Shelf Cabinet



Front Display can be either Metal Pegboard with Shelf Option or Slat Board (purchase through your supplier)



2/Parts Drawer Cabinets  
1/Cash Drawer & Shelf Cabinet



2/Shelf Cabinets  
1/Cash Drawer & Shelf Cabinet



#### SELECT FROM A VARIETY OF WORKSURFACES



Adjustable Monitoring Arms also available



# CABINETS & SHELF CONVERTERS TO OPTIMIZE YOUR PARTS STORAGE

Your Parts Department is a hub of activity. With thousands of parts of varying size and limited floor space, you need to ensure it's optimized to support the demands of your Service Department. That's why it's so crucial to give every part a home. The right home, that is.

When your parts storage area is optimized and organized, you can:

- Find what you need faster
- Increase job turnaround
- Decrease customer wait times
- Improve inventory management and cut down on inventory time
- Find storage space you didn't know you had
- Project an image of professionalism, cleanliness, and order

From parts shelving and cabinets to special tool storage and adjustable bulk storage to automated vertical storage and tire carousels, we offer complete storage solutions that accelerate productivity and help drive profitability.



## ESSENTIAL TOOL CABINETS

With a 440-lb weight capacity, high-density cabinets are strong enough to hold the heaviest parts and fully scalable to adapt to your changing inventories.



*Essential Tool Cabinets*

## WHEN IT COMES TO OEM ESSENTIAL TOOL STORAGE SYSTEMS, VIDMAR® AND LISTA® ARE THE STANDARD.

- Lockable, keyed-alike cabinets provide maximum security for all your Special Tools
- Labeled, pre-divided drawers facilitate technician efficiency, keeping them on the job – not looking for lost tools
- Drawer partitioning accessories allow you to create compartments that exactly fit the tools you need to store and make inventory a breeze

# VEHICLE SERVICES

## EYE LEVEL HEIGHT

### MODEL 340

59 in (1499 mm) high  
30 in (762 mm) wide  
27-3/4 in. (705 mm) deep

To order cabinets without locks, delete the "L" suffix from the model number  
**EXAMPLE: SEP3144LA becomes SEP3144A**



**RP3406AL**  
10 Drawers  
163 Compartments  
Usable Drawer Heights  
3-7/8 in.(98 mm)  
2-1/4 in. (57 mm)  
7 in. (178 mm)  
5-3/8 in. (137 mm)  
558 lbs. (253 kg.) Shipping Weight

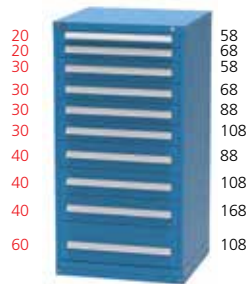

**SEP3126AL**  
10 Drawers  
164 Compartments  
Usable Drawer Heights  
2-1/4 in. (57 mm)  
3-7/8 in.(98 mm)  
5-3/8 in. (137 mm)  
8-1/2 in. (216 mm)  
565 lbs. (256 kg.) Shipping Weight

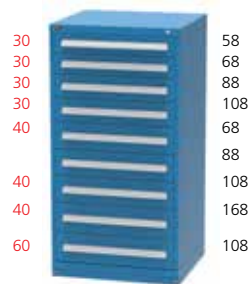

**SEP3144AL**  
9 Drawers  
140 Compartments  
Usable Drawer Heights  
3-7/8 in.(98 mm)  
5-3/8 in. (137 mm)  
8-1/2 in. (216 mm)  
538 lbs. (244 kg.) Shipping Weight

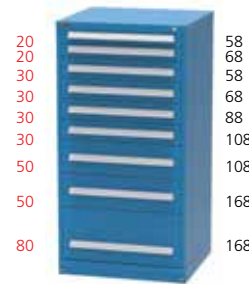

**SEP3155AL**  
9 Drawers  
144 Compartments  
Usable Drawer Heights  
2-1/4 in. (57 mm)  
3-7/8 in.(98 mm)  
7 in. (178 mm)  
11-3/4 in. (292 mm)  
529 lbs. (240 kg.) Shipping Weight

Parts Storage

## MODEL 1350 FULL DEPTH CABINET COMBINATIONS (28.5" DEEP X 57.125" HEIGHT)

■ Select: Base ■ Select: Lock □ Select: Color

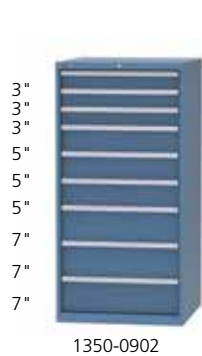

1350-0902

**Cabinet Width** SC-28.23" Wide  
Drawer Capacities 440 lbs. (200kg)

Drawers Usable Ht. (Points)	SC
3.15" (100)	DR420-100
3.15" (100)	DR420-100
3.15" (100)	DR420-100
5.12" (150)	DR316-150
5.12" (150)	DR316-150
5.12" (150)	DR316-150
7.09" (200)	DR209-200
7.09" (200)	DR209-200
7.09" (200)	DR209-200

**Cabinets**  
Without interiors SC1350-0902F-■ ■ □  
With Interiors SC1350-0902FA-■ ■ □

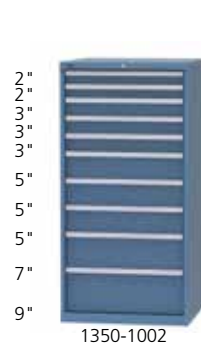

1350-1002

**Cabinet Width** SC-28.23" Wide  
Drawer Capacities 440 lbs. (200kg)

Drawers Usable Ht. (Points)	SC
2.17" (75)	DR524-75
2.17" (75)	DR524-75
3.15" (100)	DR420-100
3.15" (100)	DR420-100
3.15" (100)	DR420-100
5.12" (150)	DR316-150
5.12" (150)	DR316-150
5.12" (150)	DR316-150
7.09" (200)	DR209-200
9.06" (250)	DR104-250

**Cabinets**  
Without interiors SC1350-1002F-■ ■ □  
With Interiors SC1350-1002FA-■ ■ □

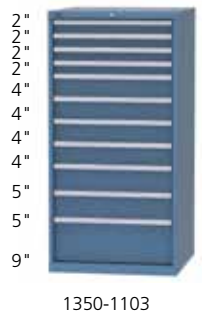

1350-1103

Drawers Usable Ht. (Points)	SC
2.17" (75)	DR320-75
2.17" (75)	DR320-75
2.17" (75)	DR320-75
2.17" (75)	DR320-75
4.13" (125)	DR316-100
4.13" (125)	DR316-100
4.13" (125)	DR316-100
4.13" (125)	DR316-100
5.12" (150)	DR312-150
5.12" (150)	DR312-150
9.06" (250)	DR104-250

**Cabinets**  
Without interiors SC1350-1103F-■ ■ □  
With Interiors SC1350-1103FA-■ ■ □



1350-0803

Drawers Usable Ht. (Points)	SC
5.12" (150)	DR312-150
5.12" (150)	DR312-150
5.12" (150)	DR312-150
5.12" (150)	DR312-150
5.12" (150)	DR312-150
7.09" (200)	DR206-200
9.06" (250)	DR206-250

**Cabinets**  
Without interiors SC1350-0803F-■ ■ □  
With Interiors SC1350-0803FA-■ ■ □

# SHELF CONVERTER

## TRANSFORM SHELVING INTO A HIGH-DENSITY STORAGE SOLUTION

### STOP STORING AIR!

- Replace inefficient shelving as your only storage solutions
- Increase storage capacity by **as much as 50% or more** by storing smaller items in Shelf Converter® System drawers. Or use your space savings to reclaim needed floor space.
- Improve retrieval time of key parts
- Upgrade to a high-density storage solution for a fraction of the cost of replacing your existing shelving
- New and improved design for faster installation
- Drawer heights ranging from 3" - 8"
- 400 lbs. Roll out tray
- Drawer capacities of 200lbs. or 400 lbs. (3" drawer only available in 200 lbs.)
- 30% increased drawer cubic capacity (from original shelf converter)
- Available frame heights: 18", 24", 36" 48"
- Available for shelf widths: 30", 36", 42" and 48"
- Available for shelf depths: 18" and 24"
- Frame is compatible with industry leading shelving manufactures including our partner Western Pacific Deluxe.





## KEY FEATURES:

- High density: With Lista Shelf Converter drawers, you use the full cubic capacity of your storage space.
- Right-sized storage: Store small-to-medium sized items in drawers, larger bulkier items on existing shelves.
- Drawer subdividing system: The Lista Shelf Converter features an extensive selection of drawer partitioning accessories allows you to create compartments that exactly fit what you're storing.
- 200 lb or 400 lb. full-extension drawers: Lista drawers stand up to the challenge of even the heaviest storage needs, holding up to 400 lbs. per drawer, even when fully extended.\*
- Easy installation: Just attach our unique frame system to your shelving uprights, insert drawer tracks and pop in the drawers.
- Expandability: As your storage needs change, the Shelf Converter System can be removed and re-installed, or added to.
- Drawer labeling system: Using our unique hinged drawer handles and free Lista Script software, you always know where everything is.
- The perfect solution for retrofitting into existing industrial shelving: Fits a number of standard shelving brands, including Western Pacific Deluxe, Metalware, Penco's Clipper®, Rousseau's Spider®, and Tennsco® Q-Line.
- Choice of sizes: Shelf Converter units available in 4 heights, 4 widths and 2 depths. Drawers are available in 6 heights. Roll-out tray can be added.
- Ideal for a number of industries and uses: The perfect solution in a wide range of manufacturing settings, maintenance and repair operations and parts cribs, as well as a lower-cost retrofit for automotive parts departments.



Shelf Converter

With traditional shelf storage (left side), you end up storing a lot of air! Smaller items make poor use of cubic space when stored on shelves, and are difficult to locate and keep track of. With the Lista Shelf Converter System (right side), you can store small-to-medium sized items in high-density drawers and larger items on shelves, where they belong.

*Clipper is a registered trademark of Penco Products Inc.  
Spider is a registered trademark of Rousseau Metal Inc.  
Tennsco is a registered trademark of Tennsco Corp.*

**\*Note:** Do not exceed the maximum storage capacity of your shelving. If total drawer loads for a Shelf Converter unit will exceed an individual shelf's maximum storage capacity according to the manufacturer's specifications, Lista recommends using two or more smaller units instead of one larger unit (for example, two 24" height units rather than one 48" height unit), with a shelf beneath each unit.



Compare the disorganized, inefficient storage in this auto dealership parts department (left) with organized storage using the Lista Shelf Converter system of shelving drawer inserts (right).

# SHELF CONVERTER®: HOW TO ORDER

## EASY TO ORDER, EASY TO INSTALL

**WE'VE MADE IT AS EASY TO ORDER A SHELF CONVERTER SYSTEM AS IT IS TO INSTALL AND USE.**

- Choose from a range of Easy-Order pre-configured units (pages 52-53).
- Or, configure your own unit to exactly suit your specific needs.
- Installation is as simple as attaching frame system, installing a pair of tracks for each drawer, and sliding the drawers into place.

A variety of the most versatile and popular configurations have been pre-designed so you can order an entire unit with just one part number. These units include not only the frame system and a full complement of drawers, but all drawers come with interior sets featuring easily installed drawer compartments (interior set must be selected).



### CUSTOM CONFIGURE A SHELF CONVERTER SYSTEM

If you want a Shelf Converter unit that doesn't match one of our Easy-Order combinations, you can build a system that exactly fits your own specific needs.

Choose frame system for the size unit you want to build, then order drawers to fill the unit. The total drawer model numbers must add up to the model number of the frame system. For roll-out trays, allow a height of at least 4". Drawers have 200 lb. and 400 lb. capacities (3" drawer only available in 200 lb. capacity).\*

*\*Note: Do not exceed the maximum storage capacity of your shelving. If total drawer loads for a Shelf Converter unit will exceed an individual shelf's maximum storage capacity according to the manufacturer's specifications, Lista recommends using two or more smaller units instead of one larger unit (for example, two 24" height units rather than one 48" height unit), with a shelf beneath each unit.*

#### EXAMPLE:

When using CVF2436 frame system on a 42" wide shelf.

- (2) CVD424/04F drawers = 8
- (2) CVD4224/06F drawers = 12
- (1) CVD4224/08F drawer = 8
- (1) CVD4224/00F tray = 8

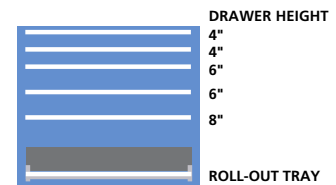

**36**



## FRAME SYSTEM KITS

PART NO.	FOR USE WITH SHELF SIZE	FRAME HT.	USES DRAWER SIZE
CVF1818- <input checked="" type="checkbox"/> <input type="checkbox"/>	30" x 18"	18"	CVD3018
	36" x 18"	18"	CVD3618
	42" x 18"	18"	CVD4218
	48" x 18"	18"	CVD4818
CVF1824- <input checked="" type="checkbox"/> <input type="checkbox"/>	30" x 18"	24"	CVD3018
	36" x 18"	24"	CVD3618
	42" x 18"	24"	CVD4218
	48" x 18"	24"	CVD4818
CVF1836- <input checked="" type="checkbox"/> <input type="checkbox"/>	30" x 18"	36"	CVD3018
	36" x 18"	36"	CVD3618
	42" x 18"	36"	CVD4218
	48" x 18"	36"	CVD4818
CVF1848- <input checked="" type="checkbox"/> <input type="checkbox"/>	30" x 18"	48"	CVD3018
	36" x 18"	48"	CVD3618
	42" x 18"	48"	CVD4218
	48" x 18"	48"	CVD4818
CVF2418- <input checked="" type="checkbox"/> <input type="checkbox"/>	30" x 24"	18"	CVD3024
	36" x 24"	18"	CVD3624
	42" x 24"	18"	CVD4224
	48" x 24"	18"	CVD4824
CVF2424- <input checked="" type="checkbox"/> <input type="checkbox"/>	30" x 24"	24"	CVD3024
	36" x 24"	24"	CVD3624
	42" x 24"	24"	CVD4224
	48" x 24"	24"	CVD4824
CVF2436- <input checked="" type="checkbox"/> <input type="checkbox"/>	30" x 24"	36"	CVD3024
	36" x 24"	36"	CVD3624
	42" x 24"	36"	CVD4224
	48" x 24"	36"	CVD4824
CVF2448- <input checked="" type="checkbox"/> <input type="checkbox"/>	30" x 24"	48"	CVD3024
	36" x 24"	48"	CVD3624
	42" x 24"	48"	CVD4224
	48" x 24"	48"	CVD4824

### HOW TO ORDER

1. Select kit.

2.  Select shelving brand.\*

**72** = Metalware

**74** = Penco's Clipper®

**81** = Rousseau's Spider®

**87** = Tensco® Q-Line

**95** = Western Pacific Deluxe

\*Call your Lista representative for other shelving brands.

Clipper is a registered trademark of Penco Products Inc. Spider is a registered trademark of Rousseau Metal Inc. Tensco is a registered trademark of Tensco Corp.

3.  Select paint color. See color chart on inside back cover.

**EXAMPLE:** to order CVF2448 Shelf Converter system for Tensco Q-Line shelving in Bright Blue paint, the part number would be **CVF2448-87-BB**.

### LOCKING OPTIONS

For added security, a Hinged Lock Bar allows Shelf Converter units to be locked with a padlock (not supplied). Must be ordered with frame system (can also be retrofit). Mounts to left side of drawer bank.

PART NO.	DESCRIPTION
CVF18HLB	CNVT HINGE LOCK BAR ASSY, 18"H
CVF24HLB	CNVT HINGE LOCK BAR ASSY, 24"H
CVF36HLB	CNVT HINGE LOCK BAR ASSY, 36"H
CVF48HLB	CNVT HINGE LOCK BAR ASSY, 48"H



## HOW TO ORDER: CONTINUED

### SHELF CONVERTER DRAWERS

Drawers shown below do not include pre-configured drawer interior sets.

#### DRAWERS FOR 30"W X 18"D SHELVING

PART NO.	LOAD CAPACITY, LBS.	DESCRIPTION	FOR USE W/ SHELF SIZE	USABLE DRAWER HT.	USABLE DRAWER DIM.
CVD3018/03N	200	30"x 18"x 3" Drawer	30"x 18"	2.25	26.1"W x 16"D
CVD3018/04F	400	30"x 18"x 4" Drawer	30"x 18"	3.25	26.1"W x 16"D
CVD3018/04N	200	30"x 18"x 4" Drawer	30"x 18"	3.25	26.1"W x 16"D
CVD3018/05F	400	30"x 18"x 5" Drawer	30"x 18"	4.25	26.1"W x 16"D
CVD3018/05N	200	30"x 18"x 5" Drawer	30"x 18"	4.25	26.1"W x 16"D
CVD3018/06F	400	30"x 18"x 6" Drawer	30"x 18"	5.25	26.1"W x 16"D
CVD3018/06N	200	30"x 18"x 6" Drawer	30"x 18"	5.25	26.1"W x 16"D
CVD3018/07F	400	30"x 18"x 7" Drawer	30"x 18"	6.25	26.1"W x 16"D
CVD3018/07N	200	30"x 18"x 7" Drawer	30"x 18"	6.25	26.1"W x 16"D
CVD3018/08F	400	30"x 18"x 8" Drawer	30"x 18"	7.25	26.1"W x 16"D
CVD3018/08N	200	30"x 18"x 8" Drawer	30"x 18"	7.25	26.1"W x 16"D
CVD3018/00F	400	30"x 18" Tray	30"x 18"	N/A	26.1"W x 16"D

#### DRAWERS FOR 30X24IN SHELVING

PART NO.	LOAD CAPACITY, LBS.	DESCRIPTION	FOR USE W/ SHELF SIZE	USABLE DRAWER HT.	USABLE DRAWER DIM.
CVD3024/03N	200	30"x 24"x 3" Drawer	30"x 24"	2.25	26.1"W x 22.1"D
CVD3024/04F	400	30"x 24"x 4" Drawer	30"x 24"	3.25	26.1"W x 22.1"D
CVD3024/04N	200	30"x 24"x 4" Drawer	30"x 24"	3.25	26.1"W x 22.1"D
CVD3024/05F	400	30"x 24"x 5" Drawer	30"x 24"	4.25	26.1"W x 22.1"D
CVD3024/05N	200	30"x 24"x 5" Drawer	30"x 24"	4.25	26.1"W x 22.1"D
CVD3024/06F	400	30"x 24"x 6" Drawer	30"x 24"	5.25	26.1"W x 22.1"D
CVD3024/06N	200	30"x 24"x 6" Drawer	30"x 24"	5.25	26.1"W x 22.1"D
CVD3024/07F	400	30"x 24"x 7" Drawer	30"x 24"	6.25	26.1"W x 22.1"D
CVD3024/07N	200	30"x 24"x 7" Drawer	30"x 24"	6.25	26.1"W x 22.1"D
CVD3024/08F	400	30"x 24"x 8" Drawer	30"x 24"	7.25	26.1"W x 22.1"D
CVD3024/08N	200	30"x 24"x 8" Drawer	30"x 24"	7.25	26.1"W x 22.1"D
CVD3024/00F	400	30"x 24" Tray	30"x 24"	N/A	26.1"W x 22.1"D

#### DRAWERS FOR 36X18IN SHELVING

PART NO.	LOAD CAPACITY, LBS.	DESCRIPTION	FOR USE W/ SHELF SIZE	USABLE DRAWER HT.	USABLE DRAWER DIM.
CVD3618/03N	200	36"x 18"x 3" Drawer	36"x 18"	2.25	32.1"W x 16"D
CVD3618/04F	400	36"x 18"x 4" Drawer	36"x 18"	3.25	32.1"W x 16"D
CVD3618/04N	200	36"x 18"x 4" Drawer	36"x 18"	3.25	32.1"W x 16"D
CVD3618/05F	400	36"x 18"x 5" Drawer	36"x 18"	4.25	32.1"W x 16"D
CVD3618/05N	200	36"x 18"x 5" Drawer	36"x 18"	4.25	32.1"W x 16"D
CVD3618/06F	400	36"x 18"x 6" Drawer	36"x 18"	5.25	32.1"W x 16"D
CVD3618/06N	200	36"x 18"x 6" Drawer	36"x 18"	5.25	32.1"W x 16"D
CVD3618/07F	400	36"x 18"x 7" Drawer	36"x 18"	6.25	32.1"W x 16"D
CVD3618/07N	200	36"x 18"x 7" Drawer	36"x 18"	6.25	32.1"W x 16"D
CVD3618/08F	400	36"x 18"x 8" Drawer	36"x 18"	7.25	32.1"W x 16"D
CVD3618/08N	200	36"x 18"x 8" Drawer	36"x 18"	7.25	32.1"W x 16"D
CVD3618/00F	400	36"x 18" Tray	36"x 18"	N/A	32.1"W x 16"D

#### DRAWERS FOR 36X24IN SHELVING

PART NO.	LOAD CAPACITY, LBS.	DESCRIPTION	FOR USE W/ SHELF SIZE	USABLE DRAWER HT.	USABLE DRAWER DIM.
CVD3624/03N	200	36"x 24"x 3" Drawer	36"x 24"	2.25	32.1"W x 22.1"D
CVD3624/04F	400	36"x 24"x 4" Drawer	36"x 24"	3.25	32.1"W x 22.1"D
CVD3624/04N	200	36"x 24"x 4" Drawer	36"x 24"	3.25	32.1"W x 22.1"D
CVD3624/05F	400	36"x 24"x 5" Drawer	36"x 24"	4.25	32.1"W x 22.1"D
CVD3624/05N	200	36"x 24"x 5" Drawer	36"x 24"	4.25	32.1"W x 22.1"D
CVD3624/06F	400	36"x 24"x 6" Drawer	36"x 24"	5.25	32.1"W x 22.1"D
CVD3624/06N	200	36"x 24"x 6" Drawer	36"x 24"	5.25	32.1"W x 22.1"D
CVD3624/07F	400	36"x 24"x 7" Drawer	36"x 24"	6.25	32.1"W x 22.1"D
CVD3624/07N	200	36"x 24"x 7" Drawer	36"x 24"	6.25	32.1"W x 22.1"D
CVD3624/08F	400	36"x 24"x 8" Drawer	36"x 24"	7.25	32.1"W x 22.1"D
CVD3624/08N	200	36"x 24"x 8" Drawer	36"x 24"	7.25	32.1"W x 22.1"D
CVD3624/00F	400	36"x 24" Tray	36"x 24"	N/A	32.1"W x 22.1"D



# VEHICLE SERVICES



Shelf Converter

## DRAWERS FOR 42X18IN SHELVING

PART NO.	LOAD CAPACITY, LBS.	DESCRIPTION	FOR USE W/ SHELF SIZE	USABLE DRAWER HT.	USABLE DRAWER DIM.
CVD4218/03N	200	42"x 18"x 3" Drawer	42"x 18"	2.25	38.1"W x 16"D
CVD4218/04F	400	42"x 18"x 4" Drawer	42"x 18"	3.25	38.1"W x 16"D
CVD4218/04N	200	42"x 18"x 4" Drawer	42"x 18"	3.25	38.1"W x 16"D
CVD4218/05F	400	42"x 18"x 5" Drawer	42"x 18"	4.25	38.1"W x 16"D
CVD4218/05N	200	42"x 18"x 5" Drawer	42"x 18"	4.25	38.1"W x 16"D
CVD4218/06F	400	42"x 18"x 6" Drawer	42"x 18"	5.25	38.1"W x 16"D
CVD4218/06N	200	42"x 18"x 6" Drawer	42"x 18"	5.25	38.1"W x 16"D
CVD4218/07F	400	42"x 18"x 7" Drawer	42"x 18"	6.25	38.1"W x 16"D
CVD4218/07N	200	42"x 18"x 7" Drawer	42"x 18"	6.25	38.1"W x 16"D
CVD4218/08F	400	42"x 18"x 8" Drawer	42"x 18"	7.25	38.1"W x 16"D
CVD4218/08N	200	42"x 18"x 8" Drawer	42"x 18"	7.25	38.1"W x 16"D
CVD4218/00F	400	42"x 18" Tray	42"x 18"	N/A	38.1"W x 16"D

## DRAWERS FOR 42X24IN SHELVING

PART NO.	LOAD CAPACITY, LBS.	DESCRIPTION	FOR USE W/ SHELF SIZE	USABLE DRAWER HT.	USABLE DRAWER DIM.
CVD4224/03N	200	42"x 24"x 3" Drawer	42"x 24"	2.25	38.1"W x 22.1"D
CVD4224/04F	400	42"x 24"x 4" Drawer	42"x 24"	3.25	38.1"W x 22.1"D
CVD4224/04N	200	42"x 24"x 4" Drawer	42"x 24"	3.25	38.1"W x 22.1"D
CVD4224/05F	400	42"x 24"x 5" Drawer	42"x 24"	4.25	38.1"W x 22.1"D
CVD4224/05N	200	42"x 24"x 5" Drawer	42"x 24"	4.25	38.1"W x 22.1"D
CVD4224/06F	400	42"x 24"x 6" Drawer	42"x 24"	5.25	38.1"W x 22.1"D
CVD4224/06N	200	42"x 24"x 6" Drawer	42"x 24"	5.25	38.1"W x 22.1"D
CVD4224/07F	400	42"x 24"x 7" Drawer	42"x 24"	6.25	38.1"W x 22.1"D
CVD4224/07N	200	42"x 24"x 7" Drawer	42"x 24"	6.25	38.1"W x 22.1"D
CVD4224/08F	400	42"x 24"x 8" Drawer	42"x 24"	7.25	38.1"W x 22.1"D
CVD4224/08N	200	42"x 24"x 8" Drawer	42"x 24"	7.25	38.1"W x 22.1"D
CVD4224/00F	400	42"x 24" Tray	42"x 24"	N/A	38.1"W x 22.1"D

## DRAWERS FOR 48X18IN SHELVING

PART NO.	LOAD CAPACITY, LBS.	DESCRIPTION	FOR USE W/ SHELF SIZE	USABLE DRAWER HT.	USABLE DRAWER DIM.
CVD4818/03N	200	48"x 18"x 3" Drawer	48"x 18"	2.25	44.2"W x 16"D
CVD4818/04F	400	48"x 18"x 4" Drawer	48"x 18"	3.25	44.2"W x 16"D
CVD4818/04N	200	48"x 18"x 4" Drawer	48"x 18"	3.25	44.2"W x 16"D
CVD4818/05F	400	48"x 18"x 5" Drawer	48"x 18"	4.25	44.2"W x 16"D
CVD4818/05N	200	48"x 18"x 5" Drawer	48"x 18"	4.25	44.2"W x 16"D
CVD4818/06F	400	48"x 18"x 6" Drawer	48"x 18"	5.25	44.2"W x 16"D
CVD4818/06N	200	48"x 18"x 6" Drawer	48"x 18"	5.25	44.2"W x 16"D
CVD4818/07F	400	48"x 18"x 7" Drawer	48"x 18"	6.25	44.2"W x 16"D
CVD4818/07N	200	48"x 18"x 7" Drawer	48"x 18"	6.25	44.2"W x 16"D
CVD4818/08F	400	48"x 18"x 8" Drawer	48"x 18"	7.25	44.2"W x 16"D
CVD4818/08N	200	48"x 18"x 8" Drawer	48"x 18"	7.25	44.2"W x 16"D
CVD4818/00F	400	48"x 18" Tray	48"x 18"	N/A	44.2"W x 16"D

## DRAWERS FOR 48X24IN SHELVING

PART NO.	LOAD CAPACITY, LBS.	DESCRIPTION	FOR USE W/ SHELF SIZE	USABLE DRAWER HT.	USABLE DRAWER DIM.
CVD4824/03N	200	48"x 24"x 3" Drawer	48"x 24"	2.25	44.2"W x 22.1"D
CVD4824/04F	400	48"x 24"x 4" Drawer	48"x 24"	3.25	44.2"W x 22.1"D
CVD4824/04N	200	48"x 24"x 4" Drawer	48"x 24"	3.25	44.2"W x 22.1"D
CVD4824/05F	400	48"x 24"x 5" Drawer	48"x 24"	4.25	44.2"W x 22.1"D
CVD4824/05N	200	48"x 24"x 5" Drawer	48"x 24"	4.25	44.2"W x 22.1"D
CVD4824/06F	400	48"x 24"x 6" Drawer	48"x 24"	5.25	44.2"W x 22.1"D
CVD4824/06N	200	48"x 24"x 6" Drawer	48"x 24"	5.25	44.2"W x 22.1"D
CVD4824/07F	400	48"x 24"x 7" Drawer	48"x 24"	6.25	44.2"W x 22.1"D
CVD4824/07N	200	48"x 24"x 7" Drawer	48"x 24"	6.25	44.2"W x 22.1"D
CVD4824/08F	400	48"x 24"x 8" Drawer	48"x 24"	7.25	44.2"W x 22.1"D
CVD4824/08N	200	48"x 24"x 8" Drawer	48"x 24"	7.25	44.2"W x 22.1"D
CVD4824/00F	400	48"x 24" Tray	48"x 24"	N/A	44.2"W x 22.1"D

If you want drawer partitioning sets for your drawer interiors, choose from sets shown on pages 54-56, be sure to match the drawer height with the correct interior set height.

## EASY-ORDER PRECONFIGURED SHELF CONVERTER SYSTEMS – 18" AND 24"

■ Select: Shelving Brand □ Select: Paint Color

See page 49 for details. For paint colors see inside back cover.  
For drawer interior sets included in drawers, see pages 54-56.

**EXAMPLE:** to order an C362418/F0402A Shelf Converter unit for Tennsco Q-Line shelving without drawer interior sets, in Bright Blue paint, the part number would be **C362418/F0402-87-BB**.

### 18" HIGH



PART NO.	DIM.	DRWS.	CMPTMTS
C301818/F0302A-■□	30" x 18"	3	48
C361818/F0302A-■□	36" x 18"	3	44
C421818/F0302A-■□	42" x 18"	3	53
C481818/F0302A-■□	48" x 18"	3	58
C302418/F0302A-■□	30" x 24"	3	36
C362418/F0302A-■□	36" x 24"	3	36
C422418/F0302A-■□	42" x 24"	3	36
C482418/F0302A-■□	48" x 24"	3	42



PART NO.	DIM.	DRWS.	CMPTMTS
C301818/F0402A-■□	30" x 18"	4	72
C361818/F0402A-■□	36" x 18"	4	64
C421818/F0402A-■□	42" x 18"	4	76
C481818/F0402A-■□	48" x 18"	4	84
C302418/F0402A-■□	30" x 24"	4	60
C362418/F0402A-■□	36" x 24"	4	54
C422418/F0402A-■□	42" x 24"	4	54
C482418/F0402A-■□	48" x 24"	4	60



PART NO.	DIM.	DRWS.	CMPTMTS
C301818/F0501A-■□	30" x 18"	5	90
C361818/F0501A-■□	36" x 18"	5	100
C421818/F0501A-■□	42" x 18"	5	100
C481818/F0501A-■□	48" x 18"	5	120
C302418/F0501A-■□	30" x 24"	5	105
C362418/F0501A-■□	36" x 24"	5	75
C422418/F0501A-■□	42" x 24"	5	75
C482418/F0501A-■□	48" x 24"	5	90

### 24" HIGH



PART NO.	DIM.	DRWS.	CMPTMTS
C301824/F0404A-■□	30" x 18"	4	72
C361824/F0404A-■□	36" x 18"	4	48
C421824/F0404A-■□	42" x 18"	4	72
C481824/F0404A-■□	48" x 18"	4	72
C302424/F0404A-■□	30" x 24"	4	36
C362424/F0404A-■□	36" x 24"	4	48
C422424/F0404A-■□	42" x 24"	4	48
C482424/F0404A-■□	48" x 24"	4	48

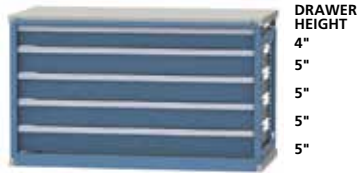

PART NO.	DIM.	DRWS.	CMPTMTS
C301824/F0506A-■□	30" x 18"	5	90
C361824/F0506A-■□	36" x 18"	5	68
C421824/F0506A-■□	42" x 18"	5	92
C481824/F0506A-■□	48" x 18"	5	96
C302424/F0506A-■□	30" x 24"	5	57
C362424/F0506A-■□	36" x 24"	5	63
C422424/F0506A-■□	42" x 24"	5	63
C482424/F0506A-■□	48" x 24"	5	66



PART NO.	DIM.	DRWS.	CMPTMTS
C301824/F0604A-■□	30" x 18"	6	108
C361824/F0604A-■□	36" x 18"	6	104
C421824/F0604A-■□	42" x 18"	6	116
C481824/F0604A-■□	48" x 18"	6	132
C302424/F0604A-■□	30" x 24"	6	102
C362424/F0604A-■□	36" x 24"	6	84
C422424/F0604A-■□	42" x 24"	6	84
C482424/F0604A-■□	48" x 24"	6	96



PART NO.	DIM.	DRWS.	CMPTMTS
C301824/F0701A-■□	30" x 18"	7	126
C361824/F0701A-■□	36" x 18"	7	140
C421824/F0701A-■□	42" x 18"	7	140
C481824/F0701A-■□	48" x 18"	7	168
C302424/F0701A-■□	30" x 24"	7	147
C362424/F0701A-■□	36" x 24"	7	105
C422424/F0701A-■□	42" x 24"	7	105
C482424/F0701A-■□	48" x 24"	7	126

# VEHICLE SERVICES

## EASY-ORDER PRECONFIGURED SHELF CONVERTER SYSTEMS – 36" AND 48"

■ Select: Shelving Brand □ Select: Paint Color

See page 49 for details. For paint colors see inside back cover.  
For drawer interior sets included in drawers, see pages 54-56.

**EXAMPLE:** to order an C362418/F0402A Shelf Converter unit for Tennsco Q-Line shelving without drawer interior sets, in Bright Blue paint, the part number would be **C362418/F0402-87-BB**.

### 36" HIGH

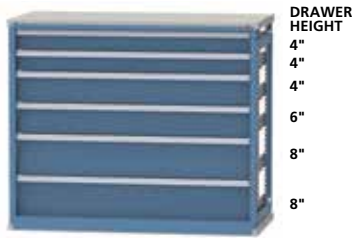

PART NO.	DIM.	DRWS.	CMPTMTS
C301836/F0604A-■□	30" x 18"	6	96
C361836/F0604A-■□	36" x 18"	6	88
C421836/F0604A-■□	42" x 18"	6	106
C481836/F0604A-■□	48" x 18"	6	116
C302436/F0604A-■□	30" x 24"	6	72
C362436/F0604A-■□	36" x 24"	6	72
C422436/F0604A-■□	42" x 24"	6	72
C482436/F0604A-■□	48" x 24"	6	84

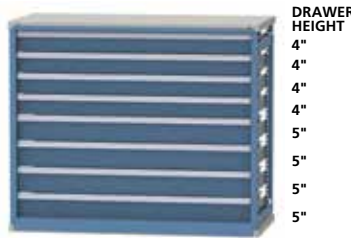

PART NO.	DIM.	DRWS.	CMPTMTS
C301836/F0805A-■□	30" x 18"	8	144
C361836/F0805A-■□	36" x 18"	8	128
C421836/F0805A-■□	42" x 18"	8	152
C481836/F0805A-■□	48" x 18"	8	168
C302436/F0805A-■□	30" x 24"	8	120
C362436/F0805A-■□	36" x 24"	8	108
C422436/F0805A-■□	42" x 24"	8	108
C482436/F0805A-■□	48" x 24"	8	120

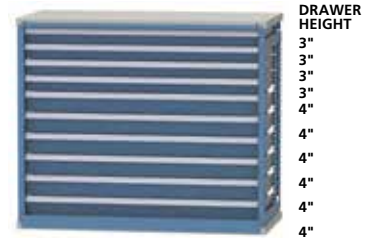

PART NO.	DIM.	DRWS.	CMPTMTS
C301836/F1002A-■□	30" x 18"	10	180
C361836/F1002A-■□	36" x 18"	10	200
C421836/F1002A-■□	42" x 18"	10	200
C481836/F1002A-■□	48" x 18"	10	240
C302436/F1002A-■□	30" x 24"	10	210
C362436/F1002A-■□	36" x 24"	10	150
C422436/F1002A-■□	42" x 24"	10	150
C482436/F1002A-■□	48" x 24"	10	180

### 48" HIGH



PART NO.	DIM.	DRWS.	CMPTMTS
C301848/F0702A-■□	30" x 18"	7	108
C361848/F0702A-■□	36" x 18"	7	84
C421848/F0702A-■□	42" x 18"	7	117
C481848/F0702A-■□	48" x 18"	7	120
C302448/F0702A-■□	30" x 24"	7	54
C362448/F0702A-■□	36" x 24"	7	75
C422448/F0702A-■□	42" x 24"	7	75
C482448/F0702A-■□	48" x 24"	7	84

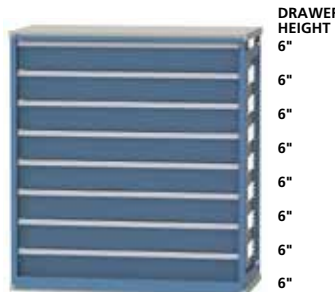

PART NO.	DIM.	DRWS.	CMPTMTS
C301848/F0801A-■□	30" x 18"	8	144
C361848/F0801A-■□	36" x 18"	8	96
C421848/F0801A-■□	42" x 18"	8	144
C481848/F0801A-■□	48" x 18"	8	144
C302448/F0801A-■□	30" x 24"	8	72
C362448/F0801A-■□	36" x 24"	8	96
C422448/F0801A-■□	42" x 24"	8	96
C482448/F0801A-■□	48" x 24"	8	96



PART NO.	DIM.	DRWS.	CMPTMTS
C301848/F1101A-■□	30" x 18"	11	198
C361848/F1101A-■□	36" x 18"	11	188
C421848/F1101A-■□	42" x 18"	11	212
C481848/F1101A-■□	48" x 18"	11	240
C302448/F1101A-■□	30" x 24"	11	183
C362448/F1101A-■□	36" x 24"	11	153
C422448/F1101A-■□	42" x 24"	11	153
C482448/F1101A-■□	48" x 24"	11	174

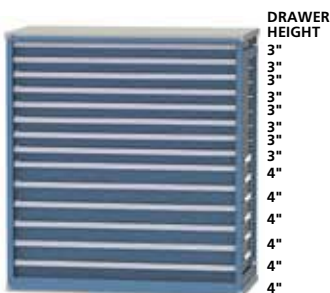

PART NO.	DIM.	DRWS.	CMPTMTS
C301848/F1401A-■□	30" x 18"	14	252
C361848/F1401A-■□	36" x 18"	14	280
C421848/F1401A-■□	42" x 18"	14	280
C481848/F1401A-■□	48" x 18"	14	336
C302448/F1401A-■□	30" x 24"	14	294
C362448/F1401A-■□	36" x 24"	14	210
C422448/F1401A-■□	42" x 24"	14	210
C482448/F1401A-■□	48" x 24"	14	252

Shelf Converter

## EASY-ORDER PRECONFIGURED SHELF CONVERTER DRAWER INTERIOR SETS

■ Select: Drawer Height

To order the drawer interior sets shown on this page when you are ordering a Shelf Converter unit without drawer interior sets, use the part number in the chart and add the drawer height in place of the green box.

**EXAMPLE:** to order an LD3024-209 drawer interior set for a 3" height drawer, the part ordering number would be LD3024-209-3.

### CVD3018 DRAWER INTERIOR SETS (USABLE INSIDE DIMENSIONS OF DRAWER 26.1"W X 16"D)



FOR CVD3018 DRAWERS		
PART NO.	NO. COMPARTMTS.	COMPART. WIDTH
LD3018-212-■	12	8 2/9"



FOR CVD3018 DRAWERS		
PART NO.	NO. COMPARTMTS.	COMPART. WIDTH
LD3018-218-■	18	8 2/9"

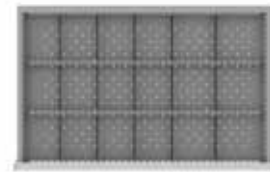

FOR CVD3018 DRAWERS		
PART NO.	NO. COMPARTMTS.	COMPART. WIDTH
LD3018-LR218-■	18	4 7/8"

### CVD3024 DRAWER INTERIOR SETS (USABLE INSIDE DIMENSIONS OF DRAWER 26.1"W X 22.1"D)



FOR CVD3024 DRAWERS		
PART NO.	NO. COMPARTMTS.	COMPART. WIDTH
LD3024-209-■	12	8 2/9"



FOR CVD3024 DRAWERS		
PART NO.	NO. COMPARTMTS.	COMPART. WIDTH
LD3024-206-■	6	8 2/9"



FOR CVD3024 DRAWERS		
PART NO.	NO. COMPARTMTS.	COMPART. WIDTH
LD3024-LR221-■	21	6 7/8"

### CVD3618 DRAWER INTERIOR SETS (USABLE INSIDE DIMENSIONS OF DRAWER 32.1"W X 16"D)

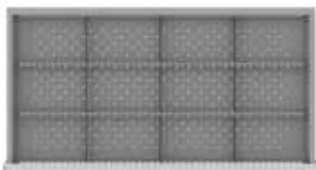

FOR CVD3618 DRAWERS		
PART NO.	NO. COMPARTMTS.	COMPART. WIDTH
LD3618-LR212-■	12	4 7/8"

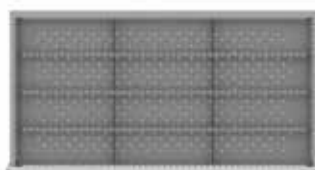

FOR CVD3618 DRAWERS		
PART NO.	NO. COMPARTMTS.	COMPART. WIDTH
LD3618-LR312-■	12	3 1/2"



FOR CVD3618 DRAWERS		
PART NO.	NO. COMPARTMTS.	COMPART. WIDTH
LD3618-420-■	4	7 5/9"
	12	6 1/5"
	4	3 1/2"



## EASY-ORDER PRECONFIGURED SHELF CONVERTER DRAWER INTERIOR SETS

### ■ Select: Drawer Height

To order the drawer interior sets shown on this page when you are ordering a Shelf Converter unit without drawer interior sets, use the part number in the chart and add the drawer height in place of the green box.

**EXAMPLE:** to order an LD3024-209 drawer interior set for a 3" height drawer, the part ordering number would be LD3024-209-3.

Shelf Converter

### CVD3624 DRAWER INTERIOR SETS (USABLE INSIDE DIMENSIONS OF DRAWER 32.1"W X 22.1"D)

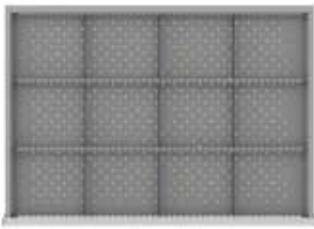

FOR CVD3624 DRAWERS		
PART NO.	NO. COMPARTMTS.	COMPART. WIDTH
LD3624-LR212-■	12	6 7/8"

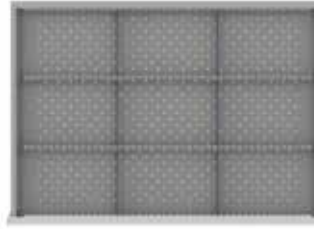

FOR CVD3624 DRAWERS		
PART NO.	NO. COMPARTMTS.	COMPART. WIDTH
LD3624-LR209-■	9	6 7/8"

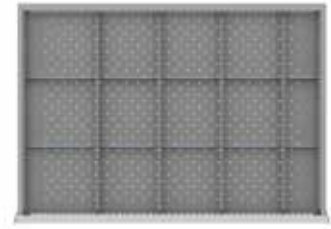

FOR CVD3624 DRAWERS		
PART NO.	NO. COMPARTMTS.	COMPART. WIDTH
LD3624-415-■	3	7 5/9"
9	6 1/5"	
3	3 1/2"	

### CVD4218 DRAWER INTERIOR SETS (USABLE INSIDE DIMENSIONS OF DRAWER 38.1"W X 16"D)

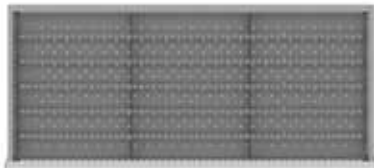

FOR CVD4218 DRAWERS		
PART NO.	NO. COMPARTMTS.	COMPART. WIDTH
LD4218-LR518-■	18	2 1/5"

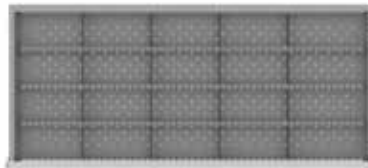

FOR CVD4218 DRAWERS		
PART NO.	NO. COMPARTMTS.	COMPART. WIDTH
LD4218-LR320-■	20	3 1/2"

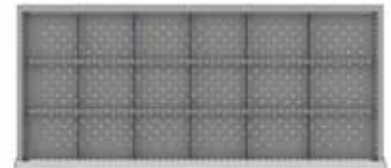

FOR CVD4218 DRAWERS		
PART NO.	NO. COMPARTMTS.	COMPART. WIDTH
LD4218-LR215-■	15	4 7/8"

### CVD4224 DRAWER INTERIOR SETS (USABLE INSIDE DIMENSIONS OF DRAWER 38.1"W X 22.1"D)

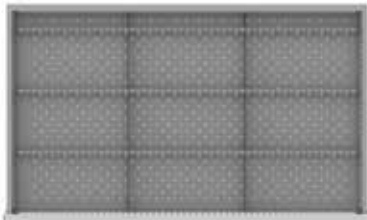

FOR CVD4224 DRAWERS		
PART NO.	NO. COMPARTMTS.	COMPART. WIDTH
LD4224-LR312-■	9	6 1/5"
	3	1 1/2"

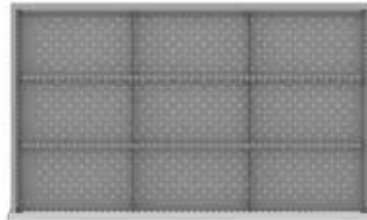

FOR CVD4224 DRAWERS		
PART NO.	NO. COMPARTMTS.	COMPART. WIDTH
LD4224-LR209-■	9	6 7/8"



FOR CVD4224 DRAWERS		
PART NO.	NO. COMPARTMTS.	COMPART. WIDTH
LD4224-LR215-■	15	6 7/8"

## EASY-ORDER PRECONFIGURED SHELF CONVERTER DRAWER INTERIOR SETS

■ Select: Drawer Height

To order the drawer interior sets shown on this page when you are ordering a Shelf Converter unit without drawer interior sets, use the part number in the chart and add the drawer height in place of the green box.

**EXAMPLE:** to order an LD3024-209 drawer interior set for a 3" height drawer, the part ordering number would be LD3024-209-3.

### CVD4818 DRAWER INTERIOR SETS (USABLE INSIDE DIMENSIONS OF DRAWER 44.2"W X 16"D)



FOR CVD4818 DRAWERS  
PART NO. LD4818-524-■ NO. COMPARTMTS. 24 COMPART. WIDTH 6 7/8"



FOR CVD4818 DRAWERS  
PART NO. LD4818-518-■ NO. COMPARTMTS. 18 COMPART. WIDTH 6 7/8"

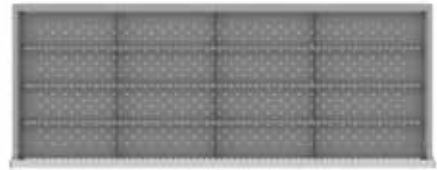

FOR CVD4818 DRAWERS  
PART NO. LD4818-LR316-■ NO. COMPARTMTS. 16 COMPART. WIDTH 3 1/2"

### CVD4824 DRAWER INTERIOR SETS (USABLE INSIDE DIMENSIONS OF DRAWER 44.2"W X 22.1"D)



FOR CVD4824 DRAWERS  
PART NO. LD4824-518-■ NO. COMPARTMTS. 18 COMPART. WIDTH 6 7/8"



FOR CVD4824 DRAWERS  
PART NO. LD4824-312-■ NO. COMPARTMTS. 9 COMPART. WIDTH 11 4/7"  
3 7 5/9"

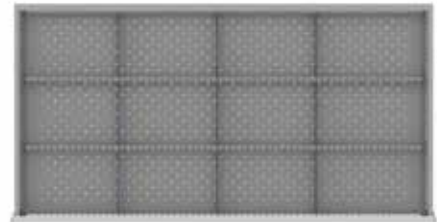

FOR CVD4824 DRAWERS  
PART NO. LD4824-LR212-■ NO. COMPARTMTS. 12 COMPART. WIDTH 6 7/8"

## DRAWER SIDE PANELS

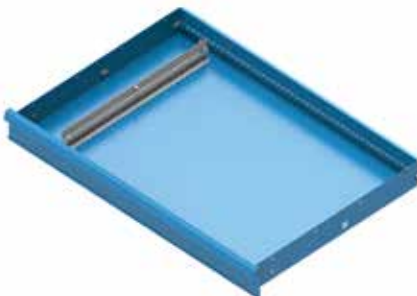

CVSP-18/3	CNVT SIDE PANEL, 3"H x 18"D
CVSP-18/4	CNVT SIDE PANEL, 4"H x 18"D
CVSP-18/6	CNVT SIDE PANEL, 6"H x 18"D
CVSP-18/8	CNVT SIDE PANEL, 8"H x 18"D
CVSP-24/3	CNVT SIDE PANEL, 3"H x 24"D
CVSP-24/4	CNVT SIDE PANEL, 4"H x 24"D
CVSP-24/6	CNVT SIDE PANEL, 6"H x 24"D
CVSP-24/8	CNVT SIDE PANEL, 8"H x 24"D

*\*Side panels must be ordered separately if not selecting a pre-configured unit in order to sub-divide drawer*



## SHELF CONVERTER®: ADDITIONAL SOLUTIONS

### DRAWER INTERIOR LAYOUT CHART

#### 3018 DRAWER INTERIOR SETS IN "A" CONFIGURATIONS

DRAWER HEIGHT	SET NO.	# COMPARTMENTS
3"	LD3018-LR218-3	18
4"	LD3018-LR218-4	18
5"	LD3018-218-4	18
6"	LD3018-218-6	18
7"	LD3018-212-6	12
8"	LD3018-212-8	12

#### 3024 DRAWER INTERIOR SETS IN "A" CONFIGURATIONS

DRAWER HEIGHT	SET NO.	# COMPARTMENTS
3"	LD3024-LR221-3	21
4"	LD3024-LR221-4	21
5"	LD3024-209-4	9
6"	LD3024-209-6	9
7"	LD3024-206-6	6
8"	LD3024-206-8	6

#### 3618 DRAWER INTERIOR SETS IN "A" CONFIGURATIONS

DRAWER HEIGHT	SET NO.	# COMPARTMENTS
3"	LD3618-420-3	20
4"	LD3618-420-4	20
5"	LD3618-LR312-4	12
6"	LD3618-LR312-6	12
7"	LD3618-LR212-6	12
8"	LD3618-LR212-8	12

#### 3624 DRAWER INTERIOR SETS IN "A" CONFIGURATIONS

DRAWER HEIGHT	SET NO.	# COMPARTMENTS
3"	LD3624-415-3	15
4"	LD3624-415-4	15
5"	LD3624-LR212-4	12
6"	LD3624-LR212-6	12
7"	LD3624-LR209-6	9
8"	LD3624-LR209-8	9

#### 4218 DRAWER INTERIOR SETS IN "A" CONFIGURATIONS

DRAWER HEIGHT	SET NO.	# COMPARTMENTS
3"	LD4218-LR320-3	20
4"	LD4218-LR320-4	20
5"	LD4218-LR518-4	18
6"	LD4218-LR518-6	18
7"	LD4218-LR215-6	15
8"	LD4218-LR215-8	15

#### 4224 DRAWER INTERIOR SETS IN "A" CONFIGURATIONS

DRAWER HEIGHT	SET NO.	# COMPARTMENTS
3"	LD4224-LR215-3	15
4"	LD4224-LR215-4	15
5"	LD4224-LR312-4	12
6"	LD4224-LR312-6	12
7"	LD4224-LR209-6	9
8"	LD4224-LR209-8	9

#### 4818 DRAWER INTERIOR SETS IN "A" CONFIGURATIONS

DRAWER HEIGHT	SET NO.	# COMPARTMENTS
3"	LD4818-424-3	24
4"	LD4818-424-4	24
5"	LD4818-418-4	18
6"	LD4818-418-6	18
7"	LD4818-LR316-6	16
8"	LD4818-LR316-8	16

#### 4824 DRAWER INTERIOR SETS IN "A" CONFIGURATIONS

DRAWER HEIGHT	SET NO.	# COMPARTMENTS
3"	LD4824-418-3	18
4"	LD4824-418-4	18
5"	LD4824-LR212-4	12
6"	LD4824-LR212-6	12
7"	LD4824-312-6	12
8"	LD4824-312-8	12

Shelf Converter

# VERTICAL SOLUTIONS TO ACCELERATE PRODUCTIVITY

We offer innovative automotive storage solutions that help you do it all faster, easier, and in fewer steps.

## STAK SYSTEM®

Adjustable pallet storage provides the benefits of bulk storage with minimal footprint – so you can store more parts and less air.



## VERTICAL LIFT MODULE

Part retrieval has never been easier or faster with the automated VLM storage and retrieval system – it's the ultimate high-density modular storage solution.







## ADJUSTABLE RACKING SYSTEM

A completely flexible heavy-duty storage solution, the ARS Adjustable Racking System allows super-efficient storage of items of varying size and weight.



## TIRE CAROUSEL

Fully motorized tire carousels maximize floor space by making use of vertical space and can be custom-configured to your exact specifications.



## HOW TO ORDER

Colored squares indicate a selection needs to be made. When ordering, refer to the corresponding color key and replace the square with the code of the desired feature.

### ■ SELECT: BASE TYPE

CODE	BASE TYPE
NB	No Base
2LB	2" Leveling Base
4LB	4" Leveling Base
6LB	6" Leveling Base
FT	Fork Truck Base
2FB	2" Frame Base
4FB	4" Frame Base
6FB	6" Frame Base

### ■ SELECT: LOCK TYPE

CODE	LOCK TYPE
NL	No Lock
RG	Individual
KA	Keyed-alike
MA	Master
KP	Keypad Lock

### ■ SELECT: SHELVING BRAND

CODE	BRAND
72	Metalware
74	Penco's Clipper®
81	Rousseau's Spider®
87	Tennsco® Q-Line
95	Western Pacific Deluxe

### ■ SELECT: DRAWER HEIGHT

Replace green square with drawer height

**EXAMPLE:** to order an LD3024-209 drawer interior set for a 3" height drawer, the part ordering number would be LD3024-209-3.

*Clipper is a registered trademark of Penco Products Inc.  
Spider is a registered trademark of Rousseau Metal Inc.  
Tennsco is a registered trademark of Tennsco Corp.*

# VEHICLE SERVICES

## SELECT: PAINT COLOR

### LISTA CABINET COLORS



**CODE COLOR**  
BE Beige

**CODE COLOR**  
BB\* Bright Blue



**CODE COLOR**  
BK\* Black

**CODE COLOR**  
CB Classic Blue



**CODE COLOR**  
GR Dark Gray

**CODE COLOR**  
GG Green

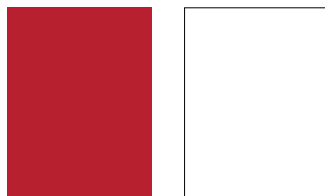

**CODE COLOR**  
NR Red

**CODE COLOR**  
FW White

### TECH SERIES TOOLBOX COLORS



**CODE COLOR**  
239 Blaze Blue

**CODE COLOR**  
5003 Dusk Blue



**CODE COLOR**  
BKG Black

**CODE COLOR**  
NRG Red



**CODE COLOR**  
12179 Yellow

*Tech Series Toolbox paint colors have a premium gloss finish.*

### VIDMAR CABINETS COLORS

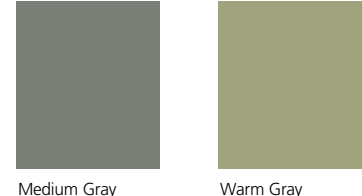

Medium Gray  
S22567

Warm Gray  
S20917



Olive Drab Green  
S22365

Off White  
S22570



Beige  
S20100

Vidmar Green  
S20606

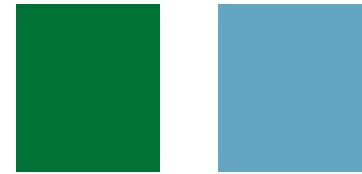

Hunter Green  
S50091

Light Blue  
S22577



Bright Blue  
S22447

Dark Blue  
S22578



Red  
S50054

Vidmar Gray<sup>†</sup>  
S23321



Black<sup>†</sup>  
S20106

<sup>†</sup> E-Series Storage Solutions only available in these colors.

Color Options



[www.vidmar.com](http://www.vidmar.com)

11 Grammes Road, Allentown, PA 18103  
USA/Canada: 800-523-9462



[www.listaintl.com](http://www.listaintl.com)

106 Lowland Street, Holliston, MA 01746-2094  
USA/Canada: 800-722-3020

**StanleyBlack&Decker**

